

# User Manual Milli-Q® HX 7040-7150 SD



Merck, Milli-Q, and Sigma-Aldrich are trademarks of Merck KGaA, Darmstadt, Germany or its affiliates. All other trademarks are the property of their respective owners. Detailed information on trademarks is available via publicly accessible resources.

© 2021 Merck KGaA, Darmstadt, Germany and/or its affiliates. All Rights Reserved.

The life science business of Merck operates as MilliporeSigma in the U.S. and Canada.

# Contents

<b>Legal Information</b> .....	<b>4</b>
<b>Safety Information</b> .....	<b>5</b>
<b>Recycling</b> .....	<b>6</b>
<b>Preface</b> .....	<b>7</b>
<b>Specifications</b> .....	<b>8</b>
Feed Water Specifications.....	9
Product Water Specifications.....	10
System Dimensions.....	11
Weight Specifications.....	12
Electrical Specifications.....	13
Environmental Specifications.....	14
<b>System Overview</b> .....	<b>15</b>
Operating Principle .....	17
<b>System Display</b> .....	<b>18</b>
How to Navigate Between Overview and Workspace Screens.....	19
Overview Screen.....	20
How to Change the System from Standby to Ready.....	24
Workspace Screens.....	26
Glance Workspace.....	27
Maintenance Workspace.....	31
Configuration Workspace.....	33
How to View Hidden Applications.....	37
Alarms and Alerts - Definition.....	38
How to Acknowledge Alarms and Alerts.....	39
Screensaver.....	40
<b>Maintenance</b> .....	<b>41</b>
How to Use Maintenance Wizard.....	42
RO Cleaning tools.....	43
RO Cleaning.....	43
Loop Filter (Opticap) option on distribution loop.....	45
How to replace (install) Loop Filter.....	46
<b>Communication Ports &amp; Software</b> .....	<b>50</b>
How to Change the Network Configuration.....	51
<b>How to Power On and Power Off the Water System</b> .....	<b>53</b>
<b>How to Use the Distribution Schedule</b> .....	<b>54</b>
<b>How to Flush the Tank</b> .....	<b>56</b>

<b>Ordering Information.....</b>	<b>57</b>
Consumable Catalogue Numbers.....	58
Accessory Catalogue Numbers .....	59
System Catalogue Numbers.....	62
<b>Appendix.....</b>	<b>63</b>
Display Icon Description.....	64
System Operating modes.....	68

## Legal Information

---

### Notice

It has always been Millipore S.A.S. policy to continuously improve its products.

The information in this document is subject to change without notice and should not be construed as a commitment by Millipore S.A.S. Millipore S.A.S. assumes no responsibility for any errors that might appear in this document. This manual is believed to be complete and accurate at the time of publication. In no event shall Millipore S.A.S. be liable for incidental or consequential damages in connection with or arising from the use of this manual.

We manufacture and sell water purification systems designed to produce pure or ultrapure water with specific characteristics ( $\mu\text{S}/\text{cm}$ , °C, TOC, CFU/ml, EU/ml) when it leaves the water purification system provided that the systems are fed with water quality within specifications, and properly maintained as recommended by the supplier.

We do not warrant these systems for any specific application. It is up to the end user to determine if the quality of the water produced by our systems matches his expectations, fits with norms/legal requirements and to bear responsibility resulting from the usage of the water.

### Product Warranty and limitation of liability

The applicable warranty and limitation of liability for the products listed in this publication may be found at <http://www.sigmaaldrich.com/> within the "Conditions of Sale" applicable to your purchase transaction.

### Copyright

© 2018 MILLIPORE S.A.S. PRINTED IN FRANCE. ALL RIGHTS RESERVED. THIS BOOK OR PARTS THEREOF MAY NOT BE REPRODUCED IN ANY FORM WITHOUT THE WRITTEN PERMISSION OF MILLIPORE S.A.S.

The photographs illustrating the products are non-contractual.

### Trademarks

Elix and Progard are registered trademarks of Merck KGaA, Darmstadt, Germany.





The " M " logo is registered trademark of Merck KGaA, Darmstadt, Germany.

All other trademarks are trademarks of their respective manufacturers.

**Document Reference:** USER-LRG2-HX\_SD-EN

**Revision:** V4.0

## Safety Information

Symbol	What it means
	This <u>UV RADIATION</u> sticker is used to refer to a position on the system cabinet or inside of it where exposure to UV light is possible.
	This <u>HAZARD</u> sticker is used to refer to a position on the system cabinet or inside of it that could be hazardous.
	This <u>ELECTRICAL GROUND</u> sticker is used to refer to a position on the system cabinet or inside where an electrical ground connection is made.
	This <u>ELECTRICAL HAZARD</u> sticker is used to refer to a position on the system cabinet or inside where an electrical danger could exist.
	This <u>HOT SURFACE</u> sticker is used to refer to a position on the system cabinet or inside where a hot surface could exist.

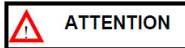

- The System must be connected to a source of electrical power that is earth grounded.
- Only an authorized person following the local safety regulations can work on this equipment.
- Unplug the electrical power cord before plugging in or removing any components on the electronic board(s).

## Recycling

---

### **Directive 2012/19/EC: For European users only.**

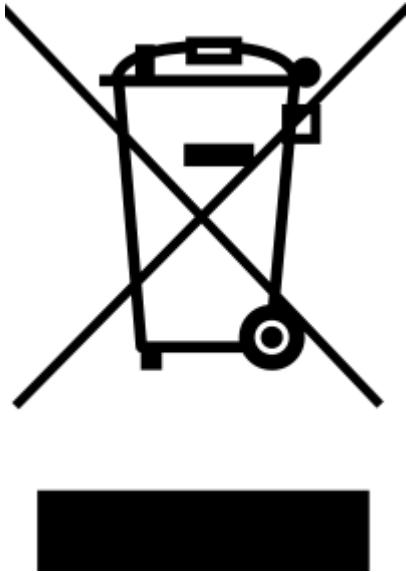

The symbol "crossed bin" on a product or its packaging indicates that the product should not be treated like household waste when discarded. Instead, the product should be disposed of at a location that handles discarded electric or electronic equipment.

Proper disposal of equipment containing electric or electronic components will help to reduce pollution effects to the environment or to human health. Proper recycling of these products helps in environmental preservation and helps to protect natural resources. For more information about recycling of products containing electric or electronic components, please contact your local recycling representative or organization.

## Preface

---

Thank you for purchasing our water purification system.

For correct operation, read and fully understand the contents of this user manual before attempting to use the system. It is recommended to store this user manual in a safe and convenient place where it can be easily referred to when required.

This user manual is intended for use with a Milli-Q® HX 7040/7080/7120/7150 SD water purification system.

The word "system" is used to refer to Milli-Q® HX 7040/7080/7120/7150 SD unless specified otherwise in the text.

The abbreviations "LC" and "HC" used after HX 7040-7080 SD refer to systems for Low Chlorine and High Chlorine feed water.

The words "display" or "HMI" (Human-Machine Interface) are used to refer to the user interface in this document.

Depending on the system type and options that are purchased, some of the features described may not apply to the system you are using.

For any questions or requests, please contact your Sales Specialist or Qualified Service Representative.

# Specifications

---



## Feed Water Specifications

The system has been designed to operate within feed water specifications:

<b>Parameter</b>	<b>Value or range</b>
Pressure	2 – 6 bar
Flow rate	> 10 L/min @ 2 bar
Feed water type	Potable water
Temperature	5 – 35° C
Conductivity	10 – 2000 µS/cm @ 25° C
pH	4 - 10
Hardness (as CaCO <sub>3</sub> )	< 300 ppm
Silica concentration	< 30 ppm
Carbon Dioxide concentration (CO <sub>2</sub> )	< 30 ppm
Langelier Saturation Index (LSI)	< 0.3
Fouling Index (FI <sub>5</sub> ) or Silt Density Index (SDI)	≤ 7 (*)
Total Organic Carbon (TOC)	≤ 1 ppm
Free chlorine for LC systems	< 1.5 ppm
Free chlorine for HC systems	1.5 ppm - 3 ppm

\* < 12 when the optional UF pretreatment unit is installed.

## Product Water Specifications

---

The system has been designed to produce water according to specifications when operating within Feed Water Specifications.

<b>Parameter</b>	<b>HX SD Systems: Value or range</b>
Resistivity	> 5 MΩ.cm @ 25°C
Conductivity	< 0.2 μS/cm @ 25 °C
Total Organic Carbon (TOC)	< 30 ppb
Bacteria	< 10 CFU/mL
Silica	<3ppb ( rejection > 99,9% )

### Applicable standards to HX SD system:

The system has been designed to be compliant with water quality standards in the laboratory.

The system produces water that meets the following requirements:

- ISO 3696: 1996 Grade 2 Water for Analytical laboratory use
- GB/T6682-2008 Grade 2 Water for Analytical laboratory use
- ASTM D1193 type 2 (2006 Reapproved 2011) Reagent Grade Water
- Japanese Industrial Standard JIS K 0557, A3 – 2008
- European Pharmacopeia Purified water 8.0
- United States Pharmacopeia Purified water (USP37)
- Chinese Pharmacopeia (2010 appendix XVII A-227) Water for Pharmaceutical Purposes
- Japanese Pharmacopeia (17-2016) Purified Water

# System Dimensions

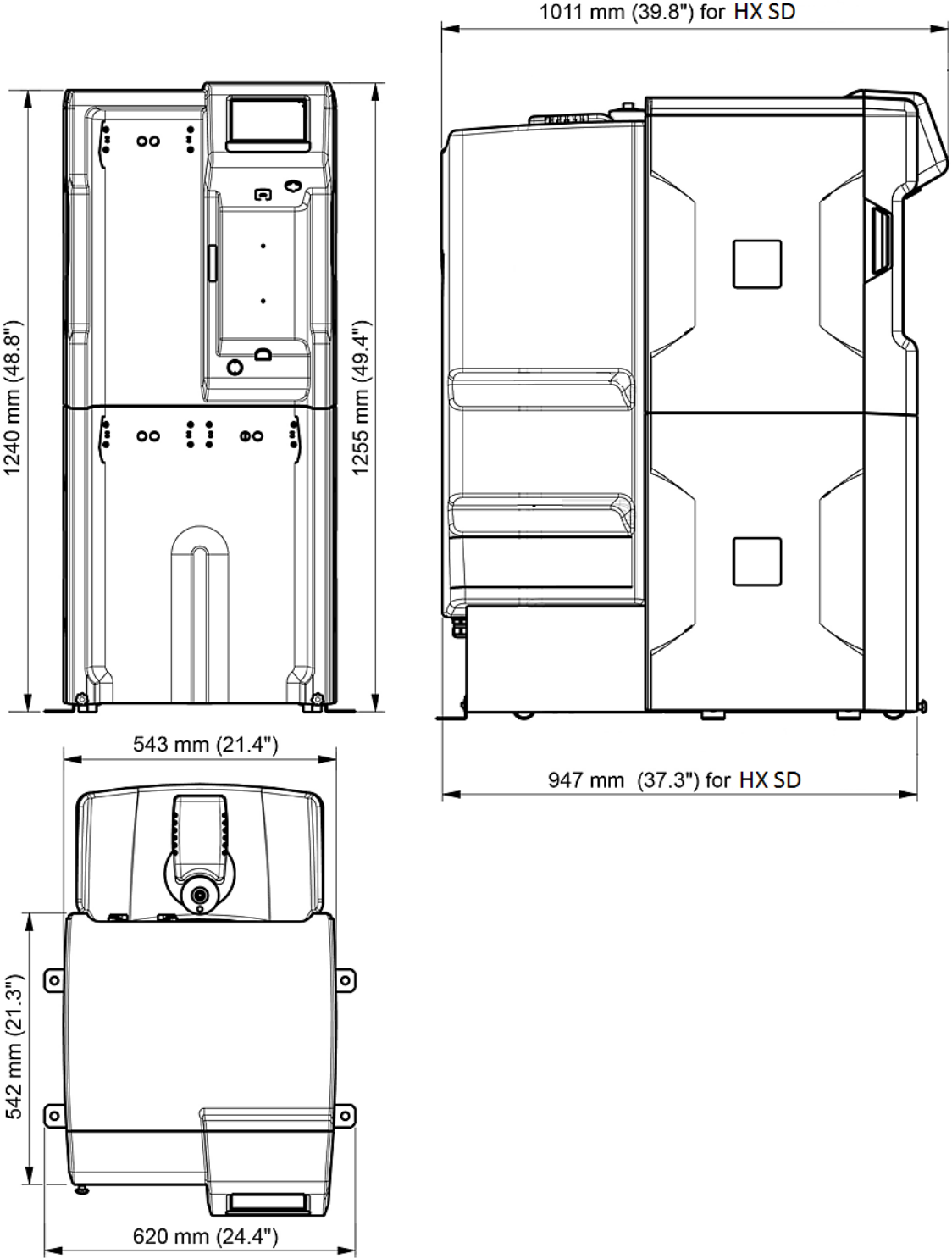

## Weight Specifications

---

The location where the Water Purification System is installed will need to fully support its Operating Weight:

<b>System type</b>	<b>Dry weight (Kg/Lb)</b>	<b>Shipping weight (Kg/Lb)</b>	<b>Operating weight (Kg/Lb)</b>
Milli-Q® HX 7040 SD	97 / 214	116 / 256	247/544
Milli-Q® HX 7080 SD	106 / 234	125 / 275	256/564
Milli-Q® HX 7120 SD	114 / 251	133 / 293	264/582
Milli-Q® HX 7150 SD	126 / 278	145 / 320	276/608

**Shipping Weight** is defined as a dry system in its shipping container. It does not include the consumable or any accessories.

**Dry Weight** is defined as a system without its shipping container. It does not include the consumable or any accessories.

The UF pre filtration option weight is 22 kg / 121.3 lb

## Electrical Specifications

---

The systems can be supplied by Mains electricity 90-253 VAC with a frequency range from 48 to 62Hz.

<b>System type</b>	<b>Voltage</b>	<b>Power Consumption (VA)</b>
Milli-Q® HX 7040/7080 SD	220-240 VAC @ 50/60 Hz	750
Milli-Q® HX 7120/7150 SD	220-240 VAC @ 50/60 Hz	870
Milli-Q® HX 7040/7080 SD	120 VAC @ 60 Hz	775
Milli-Q® HX 7120/7150 SD	120 VAC @ 60 Hz	1000
Milli-Q® HX 7040/7080 SD	100 VAC @ 50/60 Hz	775
Milli-Q® HX 7120/7150 SD	100 VAC @ 50/60 Hz	1000

The source of electrical power must be earth grounded.

## Environmental Specifications

---

Environmental specifications have been defined for normal system operation.

Altitude	≤ 2000 m
Ambient operating temperature	10 – 40 °C
Relative humidity	80% up to 31°C (decreasing linearly to 50 % relative humidity at 40 °C)
Ambient storage temperature	0 – 40 °C
Ambient storage humidity	10 – 95 %
Installation category	I
Pollution degree	2
Noise level	< 50 db at 1 meter

For indoor use only

# System Overview

System, components and connections.

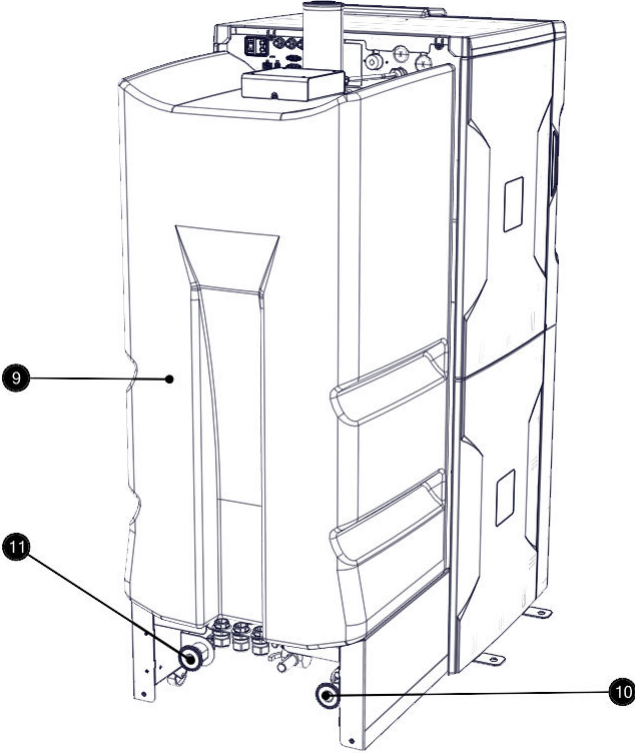
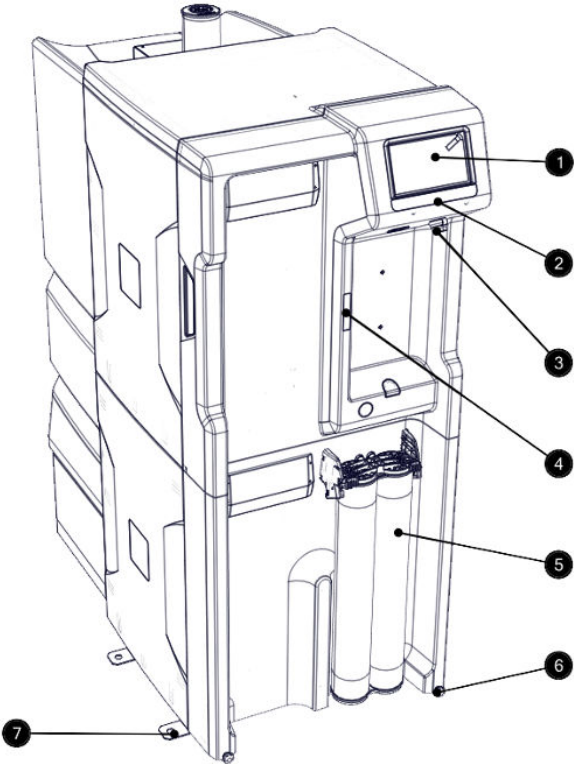

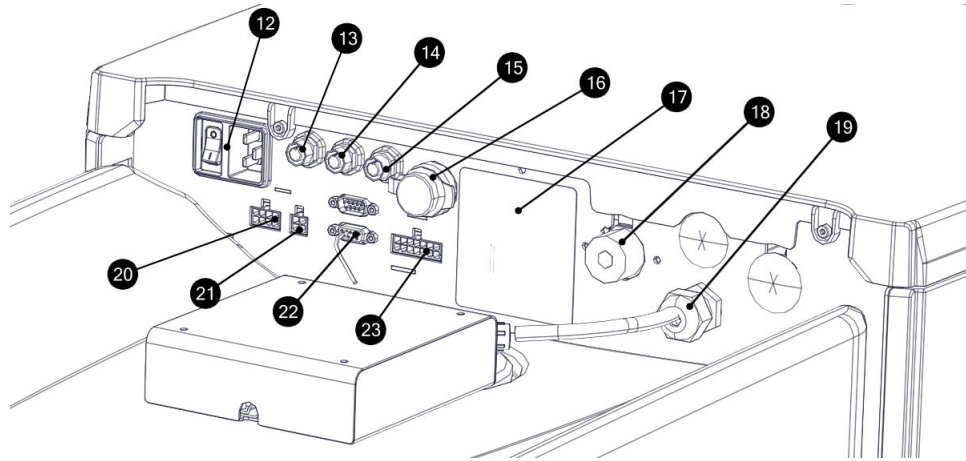

1. Display	13. DRP port (Data report: 2 Alarm output and 2 measure output)
2. System name	14. Forced distribution pump cable option
3. USB port	15. External solenoid valve port
4. Matrix code (containing system serial number and type)	16. Ethernet port
5. Progard® pack(s)	17. System type identification label
6. Wheel locking nut	18. Inlet connector (3/4" BSP)
7. Securing bracket	19. Connector used for differential pressure sensor (level sensor)
9. Water storage tank	20. External pretreatment port
10. Loop Start	21. Leak detector port
11. Loop Return	22. CH <i>Overflow and tank level</i>
12. Power Entry (Mains) & Switch	23. C1 UV BOX Ballast

**Note:** The system covers can be cleaned or disinfected by using alcohol (Ethanol and Isopropanol).



## Operating Principle



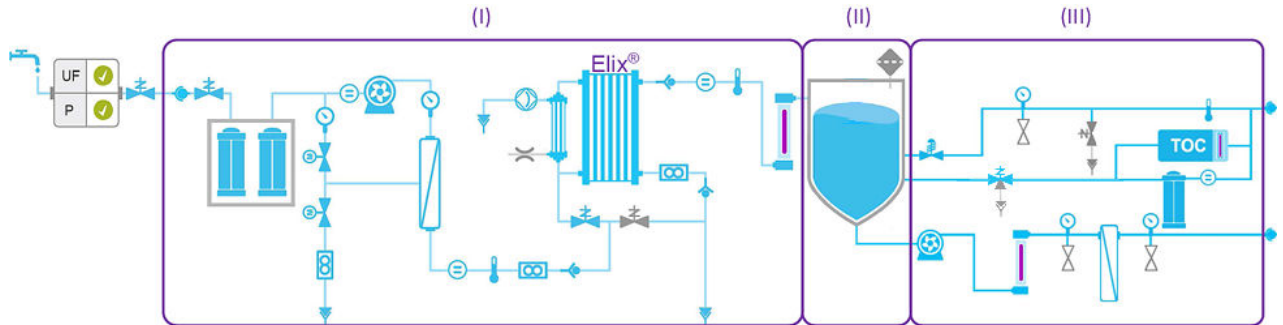

The Elix water system is designed to produce Type 2 water to feed a 150 L reservoir and to manage a distribution loop and accessories when installed.

- The water system purifies tap water using a Progard® Pack(s) and Reverse Osmosis followed by Elix® Technology. This process is called **Makeup** (I).
- The purified water is then stored in a tank. This is referred to as **Storage** (II).
- The stored water can be distributed to a loop . This process is called **Distribution** (III).

HX 7040/7080/7120/7150 SD flow schematic:



This view and more information about components can be retrieved using the **Flow**

**Schematic** application  at   

(**Glance Workspace > Flow Schematic**)

The volume of water in the Tank controls Makeup water production.

The storage part of the system is passive. The volume of water in the tank is a function of both the Makeup and Distribution processes.

**Ready** mode is used to get the processes operating.

**Standby** mode is used to stop the corresponding process in the event of a leak or maintenance purpose.

System operating modes are listed in the Appendix.

The Makeup and Distribution are two independent processes. When one of the processes is in standby, alarm stop or maintenance it will not stop the other process from working.

## **System Display**

---

The main display on the system is a touchscreen. Tapping display button icons moves the display between screens and launches applications.

The Overview screen is the main screen. The Workspace screens ( Glance, Maintenance and Configuration) contain the system applications.

## How to Navigate Between Overview and Workspace Screens

- Navigation between the **Overview** screen and the **Workspace** screens is done using the display icon buttons on the bottom right of the screens.

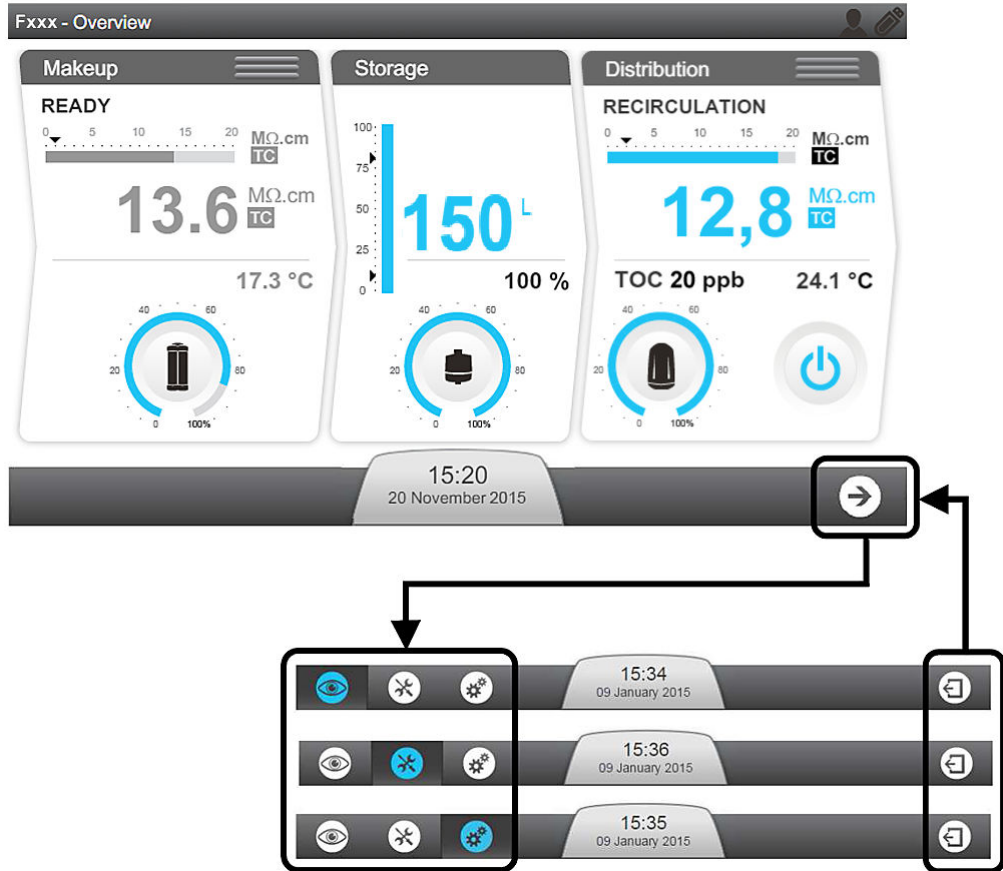

From **Overview** when tapping the arrow icon , **Glance Workspace** is always the first screen opened.

- The return to **Overview** can be made from any of the three **Workspace** screens by using the Exit icon .

## Overview Screen

The **Overview** screen is the default view on the system display. It is divided into 3 sections and each section represents one of the 3 parts of the water system.

**Figure 1: Overview Screen**

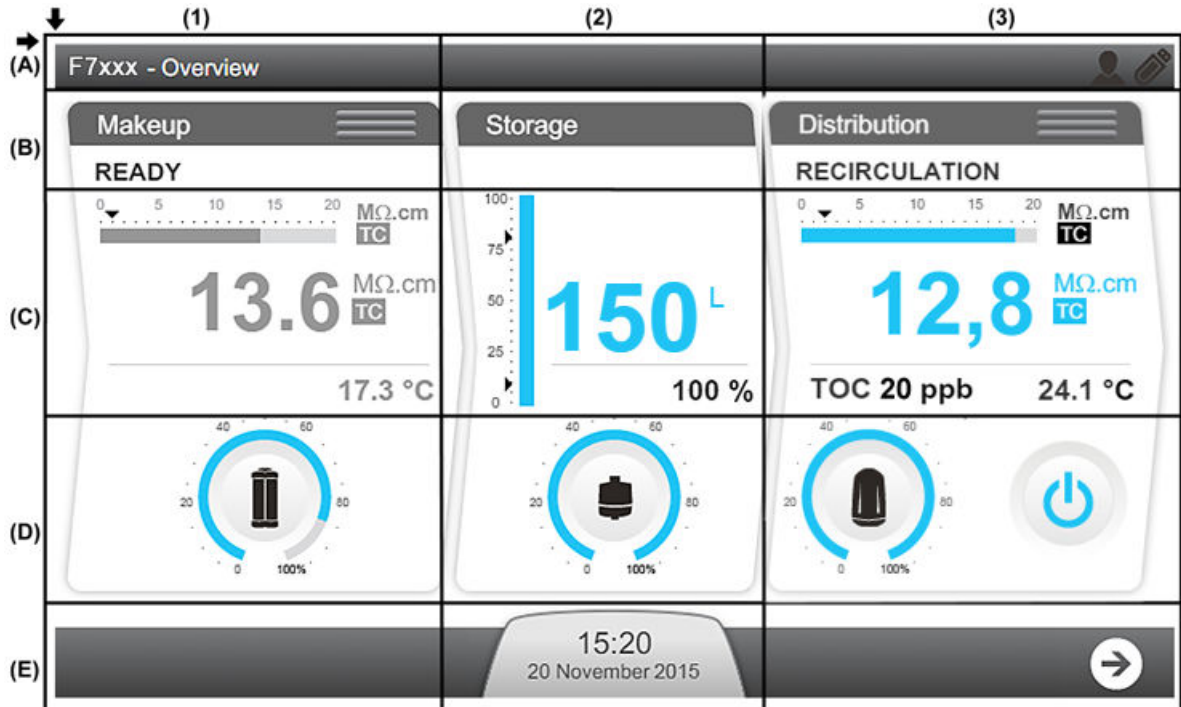

**(1): Makeup** - information on Makeup process

**(2): Storage** - information on Storage portion

**(3): Distribution** - information on Distribution process

**(A): Top banner - System Information**

A1: Screen Identifier - Overview

A3: Connectivity (external interfaces: Ethernet and USB)

**(B): Water System Process Identifier and Operating Mode**

B1: Makeup process is in **READY** mode.

B3: Distribution process is in **RECIRCULATION** mode.

The system operating modes are described in the appendix.

**(C): Measure Widgets** (measure widgets are blue when the process is active or grey if it is not active)

C1: Measures from the Makeup process

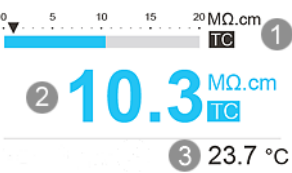

	1	Bar graph showing water quality in MΩ.cm @ 25°C and the alarm setpoint (black triangle). Available only on HX systems.
	2	Displays Makeup water quality in a user defined unit. TC is displayed when Temperature Compensation (TC) mode is on. On HR systems, the unit is μS.  If the water quality measured is under the setpoint, this value blinks between blue and red.
	3	Displays Makeup water temperature in a user defined unit.

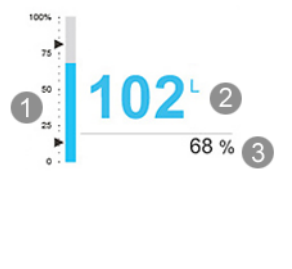
### C2: Measures from the Storage process



	1	Bar graph showing tank level in %. <ul style="list-style-type: none"> <li>• Top arrow indicates Tank Filling Restart setpoint</li> <li>• Bottom arrow indicates <b>TANK EMPTY</b> alarm setpoint</li> </ul>
	2	Displays volume of water in the Tank in a user defined unit.
	3	Displays tank level in %.

### C3: Distribution process.

The distribution can be in the following modes:

	<p>Distribution in <b>Forced mode</b>:</p> <p>Distribution process is forced to ON. Distribution loop in this mode is always recirculating.</p> <p><b>Note:</b> This function can be used to refresh the water from the distribution loop, for example after a loop sanitization or prior a sampling procedure use.</p>
	<p>Distribution in <b>Scheduled mode</b>:</p> <p>The Distribution is activated based on defined schedule.</p> <p><b>Note:</b> It is recommended to activate this mode for normal use of the system and distribution loop.</p>
	<p>Distribution in <b>Auto-recirculation mode</b>:</p> <p>An automatic recirculation occurs once every hour (15 to 60 min/h depending on the software configuration).</p> <p><b>Note:</b> It is recommended to activate this mode when the System and distribution loop are not used for a period of time.</p>

The distribution panel will be displayed according to the distribution configuration of the system:

With distribution kits installed	Without distribution kits installed
	

With distribution kits installed:

To access the distribution modes, click on distribution mode button.

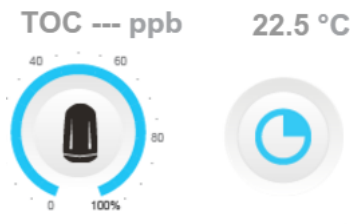

The distribution panels will show the three distribution modes. Select the desired mode:

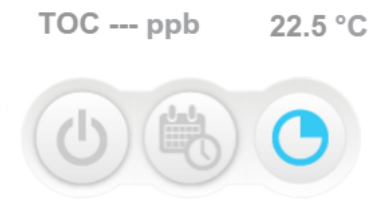

The distribution panel will return to the initial distribution screen:

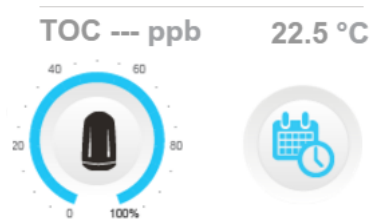

**(D): Consumable Status**

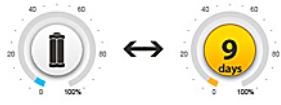
Capacity remaining (%)	Consumable due for replacement (Blinking)
	



D1: Progard® status and gauge (Depending on system type, one or two Progard® can be displayed)

D2: Vent filter status and gauge

D3: Loop filter status and gauge

**(E): Notification and Navigation bar**

E2: Notification button showing date and time. Colour changes depending on system status.

No Alert(s) or Alarm(s) Present	Alert(s) Present (Blinking)	Alarm(s) Present (Blinking)
		

E3: Navigation to Workspace screen button.

## How to Change the System from Standby to Ready

Keeping the system processes in Ready means the system automatically changes software modes to produce water when required.

**Important:** Standby should only be used to stop the corresponding process in the event of a leak or maintenance purpose.

If a process is not in a **READY** mode the operating mode will display **STANDBY**.

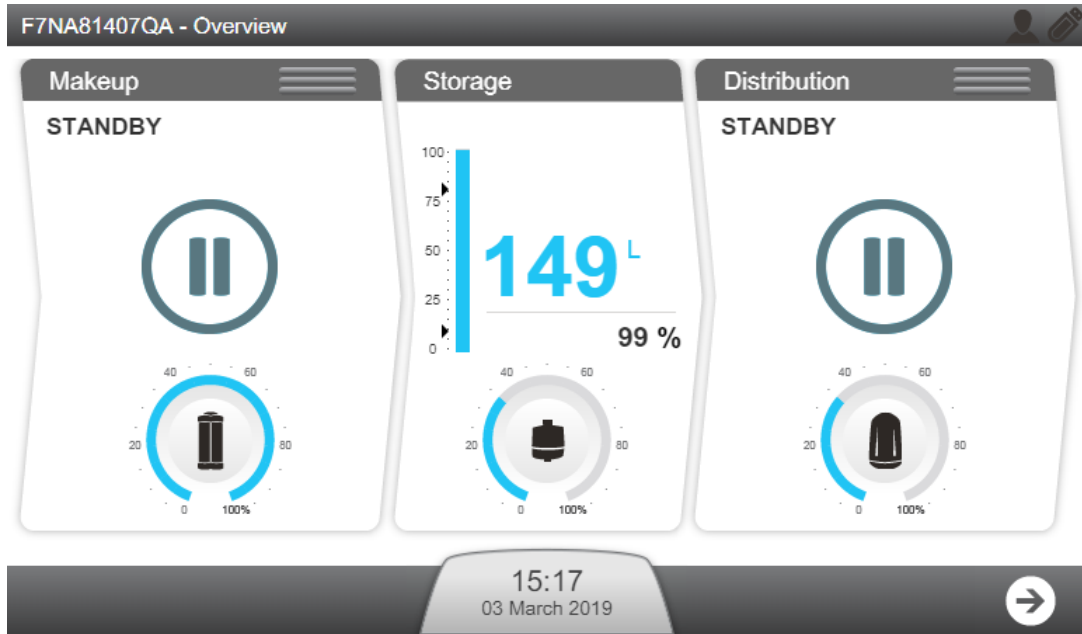

1. The Makeup and Distribution processes can be changed between **STANDBY** and **READY** using the three horizontal bars at the top of their respective window.

(I): Makeup; (II): Distribution



**Note:** When the system is not managing a distribution loop, the distribution panel is not active and in this case does not display the three horizontal bars.

2. Press on the icon on the horizontal bar of the process that you wish to change.

By clicking on the bar => Process mode switches:

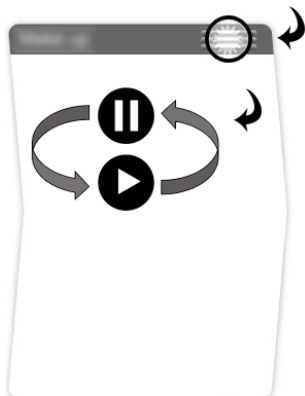



3. Confirm this action.

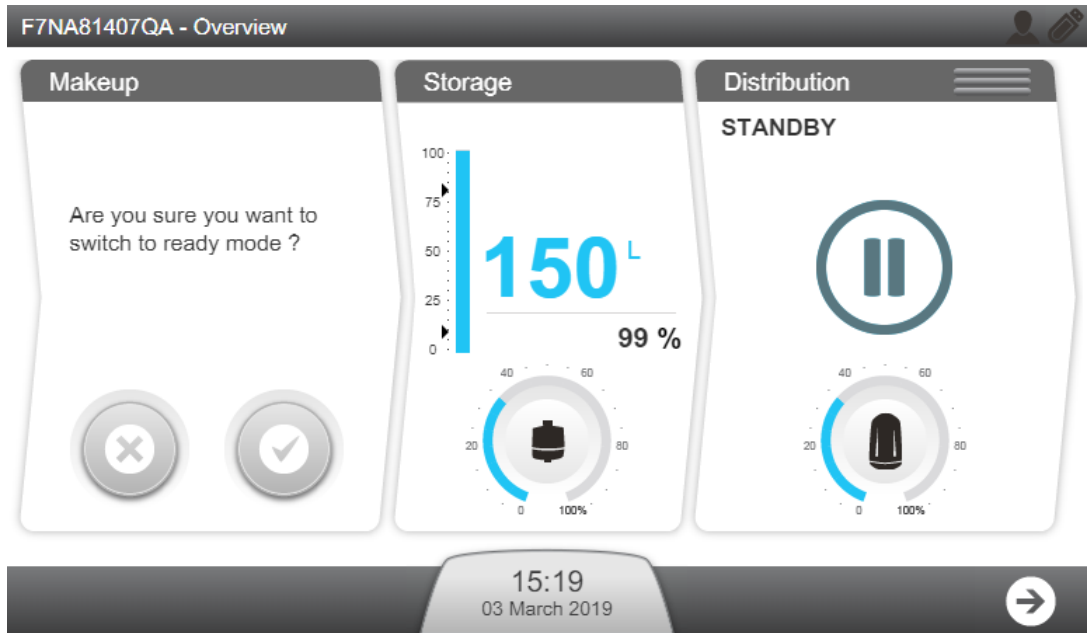

Once confirmed, the corresponding process enters in **"PLEASE WAIT"**

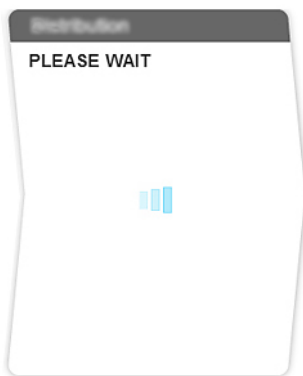

When both Makeup and Distribution processes are in Ready, the filling of the tank and loop management is automatic.

For more information, please refer to System Operating Modes in the Appendix.

## Workspace Screens

---

There are three Workspace screens, **Glance**, **Maintenance** and **Configuration** which list all available applications.

## Glance Workspace

The **Glance Workspace** contains applications providing system information.

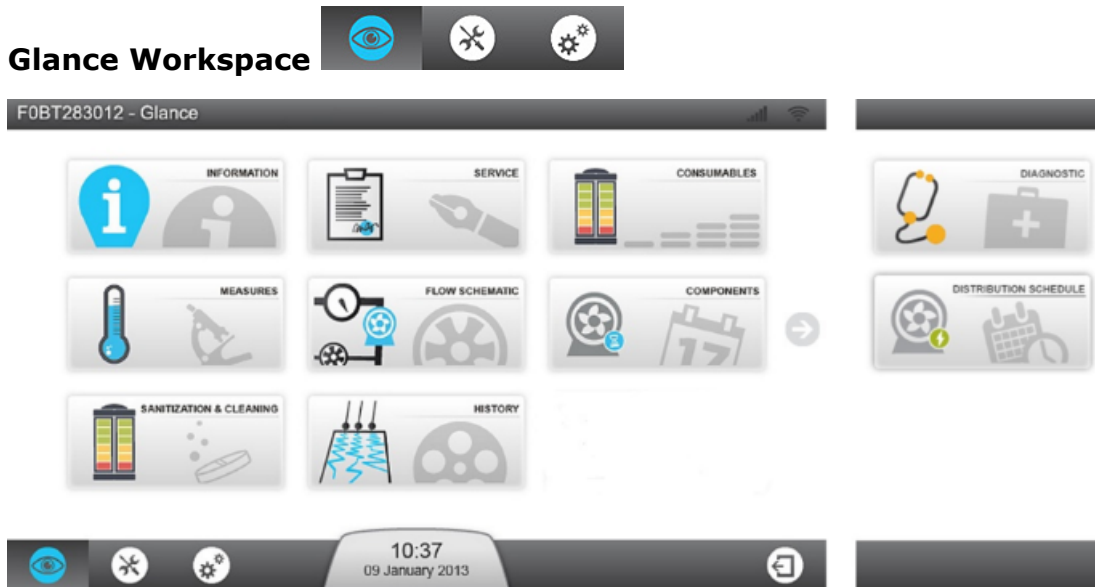

**Note:** When switching from an application back to the workspace screen, the last workspace screen selected will be opened.



**Information Application** gives information about your system.

---

**Product Information:** Unique manufacturing identifier of your system. You may need to provide some or all of this information when contacting your Sales or Service representative.

---

**Software versions:** Your water system is made of several electronic boards using different software. You may need to provide some or all of this information to your Service representative in case of troubleshooting. Software and firmware board versions are listed here.

---

**Customer information:** Details such as your location and address information can be seen here.

---



**Service Application** gives information related to Service.

---

**Key contacts:** Information about support key contacts is seen here (technical service representative or sales support contact information).

---

**Service information:** Information about your system's service agreements. It contains the installation details, and if applicable the contract name and the operational or preventive visit dates.

---



**Consumables Application** provides information related to your system's consumables.

---

**Progard® pack:** Lists the Progard® pack(s) details. The catalog number, installation date, processed volume and replacement date.

---

**RO cartridge:** Identifies your RO cartridge using type, lot and catalog number. The installation date can also be checked here.

---

**Vent filter:** Lists the tank vent filter type, lot and catalog numbers with the installation and replacement dates.

---

**Loop filter:** Lists your Loop filter details. The catalog number, installation date, processed volume and replacement date.

---



**Measures Application** gives information on the measurements from your system.

---

**Water quality measurements:**  provides information about each stage of the water purification process in the system.

- **Tap water:** Conductivity and temperature are monitored.
- **RO stage:** Conductivity, temperature and the permeate and ionic rejection outputs are monitored.
- **ELIX® stage:** On HX SD systems, the Elix® product conductivity and temperature are monitored.
- **Distribution stage:** If the kits are installed, TOC, Distribution Resistivity and temperature are displayed.

---

**Hydraulic measurements & actuator statuses:**  shows all hydraulic measurements and gives the status of each actuator.

- **Tap water:** The tap feed pressure and if applicable, the external solenoid valve status is displayed.
- **RO stage:** All parameters related to the RO stage are displayed. For example, the RO pressure, flowrate and recirculation and the different solenoid valve statuses.
- **Elix® stage:** On HX SD systems, the parameters related to the Elix® stage are displayed. In this application, the Elix® status, product flowrate and recovery, and the UV lamp status are monitored. TOC, distribution resistivity and temperature are also monitored if the options are installed in the system.
- **Storage stage:** The tank level.
- **Distribution stage:** If applicable, the distribution pump status and the dumping valve status are displayed.

---

**Electrical measurements:**  shows electrical measurements.



---

Electrical values related to the different system stages are monitored within the application.

---



**Flow Schematic Application** shows an overview of your system with a realtime updated flow schematic.

All system actuators are shown on the flow schematic. All of the different measurements are displayed, the values displayed can be sorted by water quality , hydraulic  or electrical measurement .

Pressing on a component or a consumable item will bring up a **tool tip**. The tool tip gives the item name and related information.



**Components Application** provides information about the major components of the system.

**Pumps:** Reverse Osmosis, Distribution and if applicable, Degasser pump details. The catalog number, installation and replacement date are displayed.

**UV lamps:** Catalog number, installation and replacement date are displayed for the following components: Makeup on HX SD systems only, and if installed, Distribution UV Lamp and TOC UV lamp.



**Sanitization and Cleaning Application** shows information about the sanitization and cleaning that is performed on the system. When the due date of a cleaning or sanitization nears, the system will display an alert.

**Note:** You can only visualize the consumable status information from this application. To perform consumable replacement, use the **Maintenance Workspace > Consumables Application**.

**RO membrane CL<sub>2</sub> cleaning:** The last and next CL<sub>2</sub> cleaning to be performed are displayed. If the option has been activated in the system.

**RO membrane pH cleaning:** The last and next pH cleaning to be performed are displayed. If the option has been activated in the system.



**History Application** provides historical information relating to your system. The System data can be filtered by date and the selected data can be exported in xml files.

---

**Daily measurements:** Historical daily system measurements and internal parameters can be viewed and retrieved. These parameters represent an indicator of the system performance.

---

**Daily operations:** The system creates a daily journal that contains information about all operations performed on it. Typical values registered include the water volume processed and the number of working hours.

---

**Event record:** Event records like power on, power off, operating modes or the operations that trigger alarms or alerts can be viewed and retrieved.

---



**Distribution Schedule Application** shows the Distribution schedule (if the system manages a distribution loop).

---

**Auto-recirculation:** distribution loop automatically recirculates once per hour during the period scheduled. (Auto-recirculation cycle duration can be adjusted from 15 to 60min /hour by your Qualified Service representative)

---

**Recirculation:** distribution loop recirculation is forced during the period scheduled.

---

**Tank flush:** water is discarded from the reservoir during the period scheduled.

---



**Diagnostic Application** allows the system log files to be downloaded in order to be sent to Service Representative for diagnostic purposes.

---

## Maintenance Workspace

The **Maintenance Workspace** contains applications enabling maintenance and cleanings to be performed.

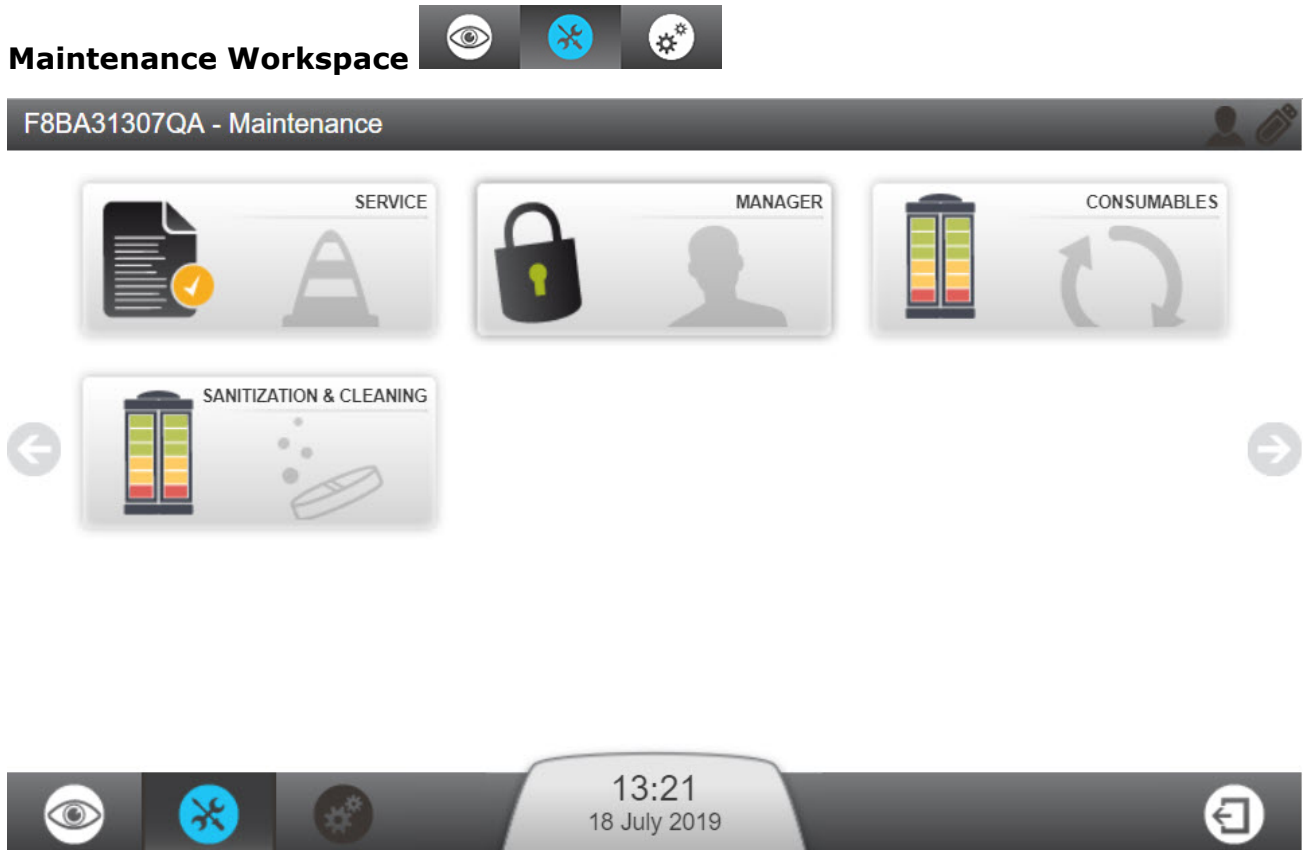

**Service Application** allows your qualified service representative to adjust and optimize system parameters dependent on usage and final application.



**Manager Application** allows access to the system Configuration Workspace.

**Note:** to use this feature, it needs to be activated by your qualified service representative. It is then accessed at any time via a password (provided by the service representative). Typically, the password is kept by a user nominated Manager. The password can be changed at any time.



**Consumables Application** shows consumable status and allows consumable software wizards to be launched.

**Note:** You can visualize the same consumable status information in the **Glance Workspace > Consumables Application** but you cannot perform consumable replacement from there.

---

Consumables found in this application: Progard® pack(s) and if applicable, Vent filter and distribution loop filter.

---



**Sanitization and Cleaning Application** allows cleaning software wizards to be launched.

The RO membrane cleaning wizard will guide you through the different steps, indicate the cleaning time and what is required in order to perform RO membrane cleaning. During the first steps, until reagents are introduced into the system, you will be prompted by the wizard, to validate or cancel the RO membrane cleaning.

When opening this application, two dates related to cleanings are shown:

- The "Performed" date indicates the last time a cleaning was done,
- The "Due date" indicates when the next cleaning is due.

**Note:** The cleaning timers can be adjusted in collaboration with your Qualified Service representative.

The RO membrane CL<sub>2</sub> cleaning takes around 30 min and the RO membrane pH cleaning takes around 75 min (see Maintenance Chapter for more information).

---

**Tank emptying:** Your tank will be emptied until it reaches the 0% level of water.

---

**TOC cleaning:** TOC cleaning process will be launched, the time duration is 1 hour.

---



## Configuration Workspace

The **Configuration Workspace** contains applications allowing modification of some system parameters

### Configuration Workspace



**Note:** The information shown in the configuration applications can be observed, changed and saved. Configuration applications can be accessed when manager access has been activated by a qualified service representative. It is accessed by the manager using a password. In the **Workspace Glance** applications similar information can be seen, but not changed.



**Information Application** allows modification of system information.

---

**Product information:** Parameters from the manufacturer that uniquely identify the system cannot be changed but personalization of your system is possible by giving it a name, and a location for example.

---

**Company name:** Your Company name, address and contact information can be found and changed in this application.

---

**Key contact (Add/Del/Mod):** You can add, delete or modify your contacts phone number and email from this application. These key contacts can be viewed in the **Glance Workspace > Information Application** by any system user.

---



## Processes Application

---

**Makeup process:** The Tank refill setpoint can be modified, the RO recovery setpoint can be decreased. The Tap feed pressure max. is given as information only.

---

**Distribution process:** Auto lab closed can be activated here. The auto lab closed must be activated to refresh the tank water if the system was not in tank filling for more than 3 days and the tank level is above the tank refill setpoint.

The "Auto recirculation duration" can be adjusted from 15 to 60 min per hour, and the Post recirculation from 30 to 60min per hour.

The "Tank flush setpoint" can be adjusted to the following range of value: 0-75%. The "Tank flush setpoint" must be below the "Tank refill setpoint". If not, the tank will be emptied but it will never be refilled.

---

**Options:** The water sensor (or leak detector) can be activated here.

---

**Measure outputs:** Two measures can be selected from the list of parameters, these parameters can be monitored by external devices.

---

**Units:** Set your desired units here.

---



## Alarm and Alert Application

---

**Alarm thresholds:** Thresholds corresponding to the main system parameters can be adjusted here. If a threshold has been crossed, the system will raise the corresponding alert or alarm.

**Example:** RO Low TDS setting can be activated in some particular tap feed water cases. If the tap feed water quality is too good, the RO membrane rejection performance maybe poor and based on the system RO recovery, the system could raise alarms related to the RO rejection, or tap feed conductivity. This parameter can be selected to suppress these alarms.

---

**External signals:** This option must be installed and activated by your service representative. Unlimited alerts or alarms can be selected from the list, these alarms can be reported to an external device.

---



## System Settings Application

---

**LCD:** Adjust the brightness of the display.

---

**Language:** Your system language has been set by your Qualified Service representative. However, the language can be changed using this application.

**Note:** Pay attention to the fact that with an unfamiliar language you may encounter some difficulties to return to your original language.

---

**Sound:** Sounds can be configured here.

Alarm and Alert sounds can be selected independently. You can also decide to activate Keyboard clicks.

---

**Date & Time:** The system date and time can be changed here.

**Note:** Seasonal changes to the time (i.e. Daylight Savings) are automatic.

---

**Network configuration:** The LAN communication can be configured here (fixed ip address or DHCP can be selected)

---



## Export/Import Application

---

The system configuration file can be exported from this application. It is highly recommended to export the system configuration file and keep it as a backup in order to keep your complete settings.

The configuration file can be imported into the system if it corresponds to the same system from which it has been exported previously.

---



**Distribution Schedule Application** allows scheduling of recirculation of the distribution process.

---

**Behaviours:** 3 distribution modes - Auto-recirculation, Recirculation and Tank Flush - can be programmed for each day of the week.

Auto-recirculation is set by default. Start and end times of the distribution modes can be defined and added to the distribution schedule .

---

**Copy schedule:**  the schedule defined for one day can be applied to other selected days of the week.



## How to View Hidden Applications

On a workspace screen, some of the available applications are located on a second screen.

If the workspace window contains more than the maximum application 9 available, you must change the page to access to the other available applications.

- On the left and right side of the application windows, two arrows are present. Click on these arrows to navigate through different application windows.



Clicking on the right arrow on Glance workspace will show the additional

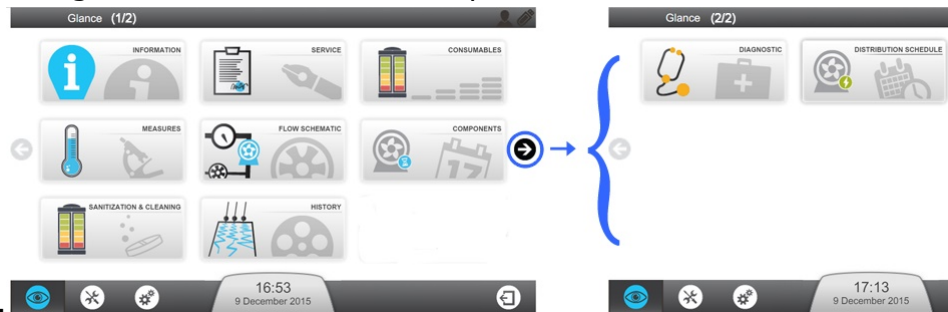

applications.

**Note:** When entering in a workspace screen that contains more than one page of applications, the first page will always be displayed.

## Alarms and Alerts - Definition

Notifications are displayed when the system has an Alarm or an Alert.

Type	Description	Examples
Alert	<p>An alert is displayed in yellow meaning that maintenance is required or a non-critical event occurs.</p> <p>The system continues to operate.</p>	<p>Replace Progard® in xx days.</p>
Alarm	<p>An alarm is displayed in red, meaning that a problem was detected by the system.</p> <p>The system continues to operate.</p>	<p>Elix Resistivity &lt; Set point.</p>
Alarm Stop	<p>An alarm is displayed in red, meaning that a critical problem was detected by the system.</p> <p>The corresponding system process is stopped : the system will not produce or distribute water until the problem is fixed.</p>	<p>Low feed water pressure.</p>

## How to Acknowledge Alarms and Alerts

Some Alarms stop the corresponding process in order to protect the system, acknowledgment of these Alarms resume the process if the cause of the alarm has been corrected. Alarm messages cannot be cleared unless the cause of the alarm has been fixed. Acknowledging Alerts clears the message for 24 hours.

To acknowledge an alarm or alert:

1. Tap on the Alarms and alerts Notification button on the **Overview** screen.  
Alarm blinking

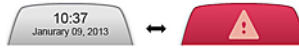

The **Alarms and Alerts** screen is opened:

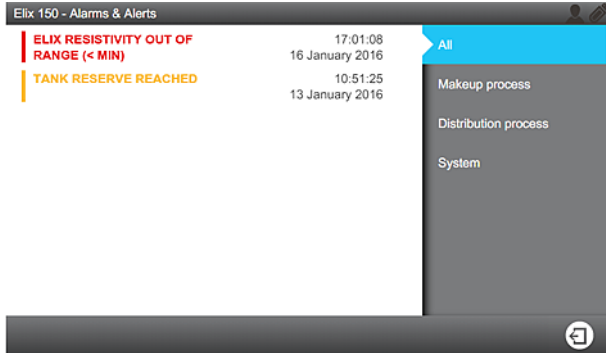

2. By clicking on a single event message a screen opens describing the alarm or alert and if required information on fixing it.

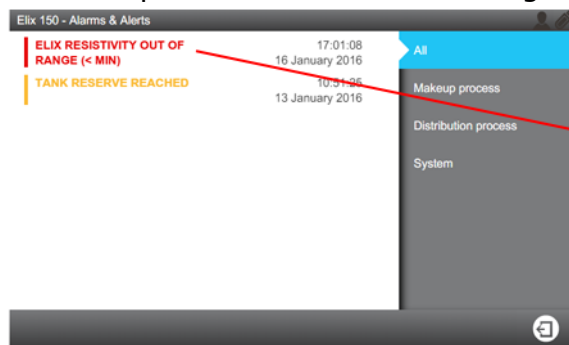

3. If the alarm requires a cleaning or a consumable replacement, a software wizard opens and guides you through the process.

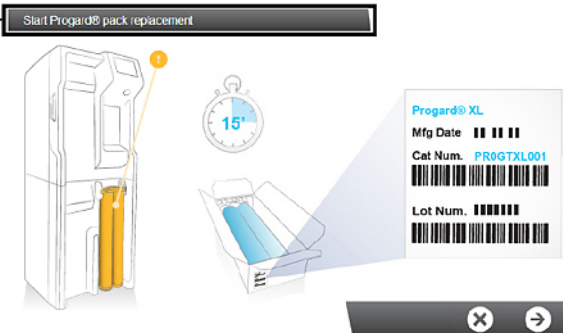
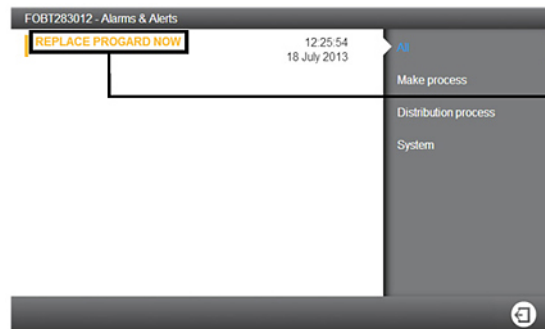





- Once Alarms are acknowledged and the cause of the alarm has been fixed the process will return to Ready.

## Screensaver

When the system is idle, a screensaver appears on the display.

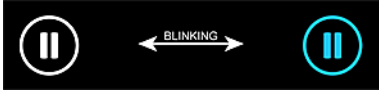
The system continues to operate and the **screensaver** displays the main system information.

### Screensaver visual states:

STANDBY		Makeup process standby and/or Distribution process are in <b>STANDBY</b> .
READY		Makeup process and Distribution process are in <b>READY</b> .
READY + ALERT		Makeup process and Distribution process are in <b>READY</b> with one or more <b>alert(s)</b> .
ALERT		One or more <b>alert(s)</b> are active. Maintenance to be performed .
ALARM + ALARM STOP		One or more <b>Alarm(s)</b> are active.

Tapping on the screen when the **screensaver** is active will wake the system and open the **Overview** screen.



## **Maintenance**

---

Alerts are triggered when a Consumable Replacement, Cleaning or Sanitization is required.

## How to Use Maintenance Wizard

Consumable Replacements, Cleanings and Sanitizations are undertaken using software wizards. The wizard for the action can be launched directly from the alert.

**Note:** The maintenance wizards can be launched in different ways. The maintenance

wizards can be launched using the **Consumables** application:



or the **Sanitization & Cleaning** application:



See Applications at the **Maintenance Workspace** chapter:



1. Tap on the Alerts Notification button on the **Overview** screen to open the Alarms and Alerts screen.

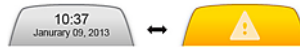

2. By clicking on a Consumable Replacement, Cleaning or Sanitization message, a software wizard is opened to guide you through the procedure.

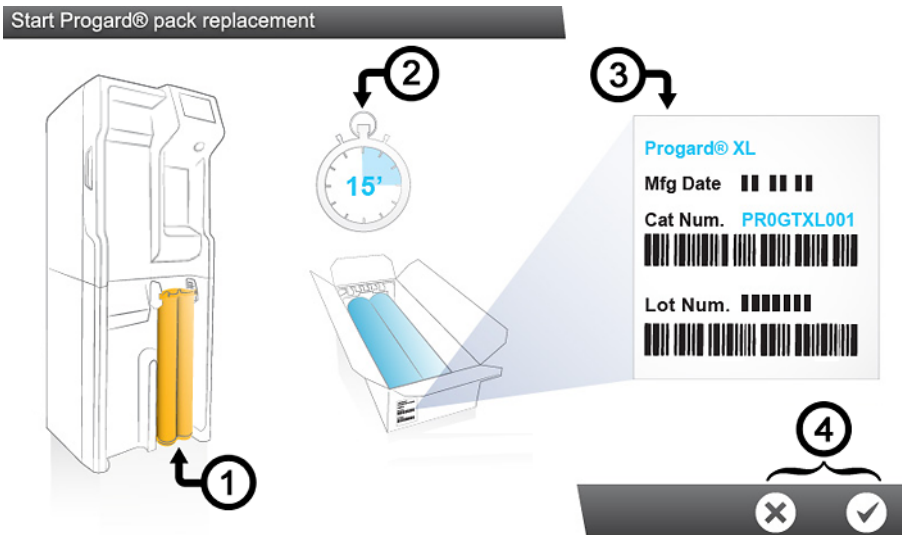

The software wizard shows:

1. The location
  2. The duration (Estimated time)
  3. The references needed
3. You can decide to launch or cancel the software wizard (4).

Once the last step is completed the software wizard closes and the corresponding alert related to the maintenance action will disappear from the list of Alarms and Alerts.

## RO Cleaning tools

---

What do you need to perform an RO membrane Cl<sub>2</sub> cleaning ?

Two solutions can be chosen to perform Cl<sub>2</sub> cleaning.

**1.** Chlorine tablets & RO regeneration tools:

- For a system with one Progard® Pack: One RO Regeneration Tool
- For a system with two Progard® Packs: One RO Regeneration Tool and one RO Regeneration Plug/Tool
- Two Chlorine tablets (RO Protect C)

**2.** Alternatively, if you can use Progard Auto-clean Packs that already contains Cl<sub>2</sub> cleaning agent.

What do you need to perform an RO membrane pH cleaning ?

- For a system with one Progard® Pack: One Regeneration Tool
- For a system with two Progard® Packs: One Regeneration Tool and one Regeneration Plug/Tool
- 1 to 3 Acid or Base pH reagent pouches depending on system type (1 for HX 7040 SD, 2 for HX 7080 SD, 3 for HX 7120 SD, HX 7150 SD)

**Note:** Your Qualified Service representative has selected, based on your tap feed water quality, the pH cleaning type that you will need to perform on your RO membranes and the pH cleaning frequency.

## RO Cleaning

---

**Table 1: RO Cleaners**

<b>RO Cleaners</b>	<b>Conditioning</b>	<b>Recommended usage</b>	<b>Action</b>
Chlorine - RO Protect C ( Cl <sub>2</sub> tablets)	Delivered as a tablet	Use periodically when prompt by the system* every 84 days or as recommended by your Service representative.	The regular use of a chlorine tablet helps to reduce biofilm formation on the surface of the RO membrane.
RO Acid Cleaner - RO Care A	Delivered in a pouch. The empty pouch is removed after use.	Use periodically when prompt by the system* or when the RO % rejection drops more than 5% and/or when the RO permeate flowrate drops more than 10%, if due to mineral scaling.	The use of RO Acid Cleaner removes some or most mineral scale buildup on the surface of the RO membranes.
RO Base Cleaner - RO Care B	Delivered in a pouch. The empty pouch is removed after use.	Use periodically when prompt by the system* or when the RO % rejection drops more than 5% and/or when the RO permeate flowrate drops more than 10%, if due to organic fouling.	The use of RO Base Cleaner removes some or most organic material buildup on the surface of the RO membranes.

*(\*): RO cleaning alerts can be activated and timers adjusted based on feed water quality.*

**Important:** Do not replace RO cleaners with other chemicals. The chemical concentration and form are not designed to fit with our cleaning program, and it may damage the RO membranes & water system.

## Loop Filter (Opticap) option on distribution loop

---

The Loop Panel Assembly kit (ZLXLSDL00PKIT) offering the possibility to include a Loop Filter (Opticap) and/or an UV lamp is available as an option and it can be added to the distribution loop to help improving the quality of water.

An exhausted Opticap will create a difference of pressure between the incoming pressure and the outgoing pressure.

1. Check the pressure values on both manometers.



2. If the pressure drop reaches **0.5 bar** or above then this will directly impact the flow in the loop. This also means that **the Opticap filter is exhausted** and needs to be replaced.

## How to replace (install) Loop Filter

---

The loop filter is connected using two tri-clamps.

1. Before replacing the Loop Filter (Opticap), put the distribution to **STANDBY** on Water Purification System interface.
2. Close the two isolation valves.

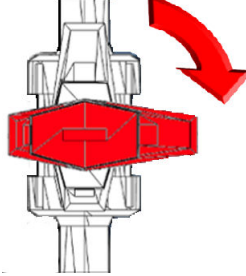

3. Make sure you have a container ready to collect spillage.
4. Before replacing, empty the installed Loop Filter :
  - a) Place the container under the Loop Filter bottom purge valve.
  - b) Open the bottom purge valve and then the top purge valve.
  - c) Collect the water.
5. Locate the 2 connection clamps.



6. Undo the clamps by turning the handles anti-clockwise.

7. Remove the used filter, or the by-pass pipe, and keep the clamps and gaskets.



8. Position the new filter between the 2 connection clamps.
9. Make sure the seals are correctly seated.
10. Close the clamps on the filter connections and make sure the clamps are well positioned.
11. Tighten the clamps by turning clockwise.



12. Return the distribution to READY and force the distribution to ON by pressing on the button.

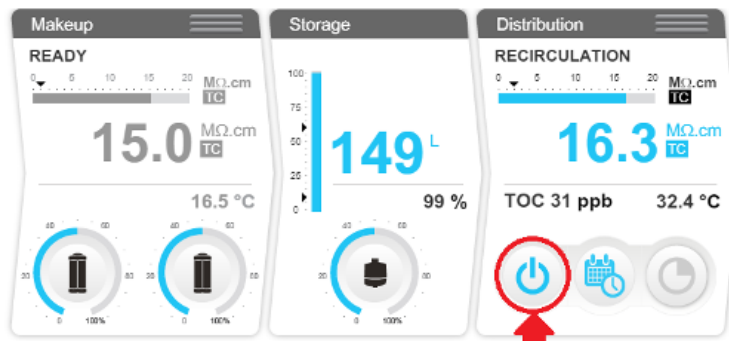

- 13.** Place a container under the purge valve of the loop filter and open the first ball valve located at the bottom of the loop panel



- 14.** Perform an air purge by opening the air purge valve of the Loop Filter.



- 15.** Close the air purge valve once the filter is full of water.
- 16.** Open the second ball valve.



- 17.** Verify the pressure level on both manometers. The pressure should be above 1 bar.



**18. Isolation valves should be open when the distribution is restarted.**

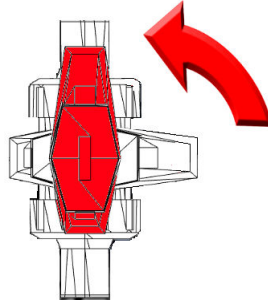

**Warning: The isolation valves should be open at all times unless Loop Filter replacement task is carried out. If the isolation valves are kept closed, the distribution will be jeopardized and, in a worst case it could also lead to the damage of the system distribution pump.**

- 19.** Enter loop filter information in the Water Purification System consumable replacement menu.

Switch distribution back on and make sure there are no leaks.

## Communication Ports & Software

---

### USB

The water system has a built-in USB port that offers the possibility to export the system data and/or history.

USB port is located just under the main display. This is a hot pluggable port that automatically detects a USB key when a compliant device is connected:

- USB 2.0 compliant,
- Type A,
- FAT16 / FAT32 under Windows® Operating System, and
- ext3 / ext4 under Linux Operating System.

### Ethernet

The water system has a built-in Ethernet port that offers the possibility to connect to a TCP/IP network.

Up to three users can connect to the system at the same time but only one single user can access applications that modify system parameters (applications found in **Configuration Workspace** as an example).

You can access to the same applications and screen views on the remote display interface and the system's main display.

**Note:** When three users are connected, the system informs any new connection that the maximum number of opened sessions has been reached.

### Supported browsers

When connected through Ethernet protocol, the display interface can be accessed remotely using the following internet web browser versions.

The remote display of the main display is compatible with the following browser versions:

**Table 2: Internet Browser Compatibility**

Browser type	Recommended version
Chrome® Software	39.0.2171.71

### System software

System software included in this product contains copyrighted software that is licensed under the GNU GPL.

Details of the legal notices relating the system software licence, claim, open source and components references can be found from the system MMI at **Glance / User Manual / Legal notices**.

You may obtain the complete Corresponding Source code from us for a period of three years after our last shipment of this product, by submitting a written request to your service representative.

## How to Change the Network Configuration

To change your Internet or Network configuration use the System Settings Application.

**Important:** The network configuration should only be changed from the system display. Do not attempt to change the settings remotely using the network.

1. From the Configuration Workspace , select the

System Settings Application .

2. Select **Network configuration**.

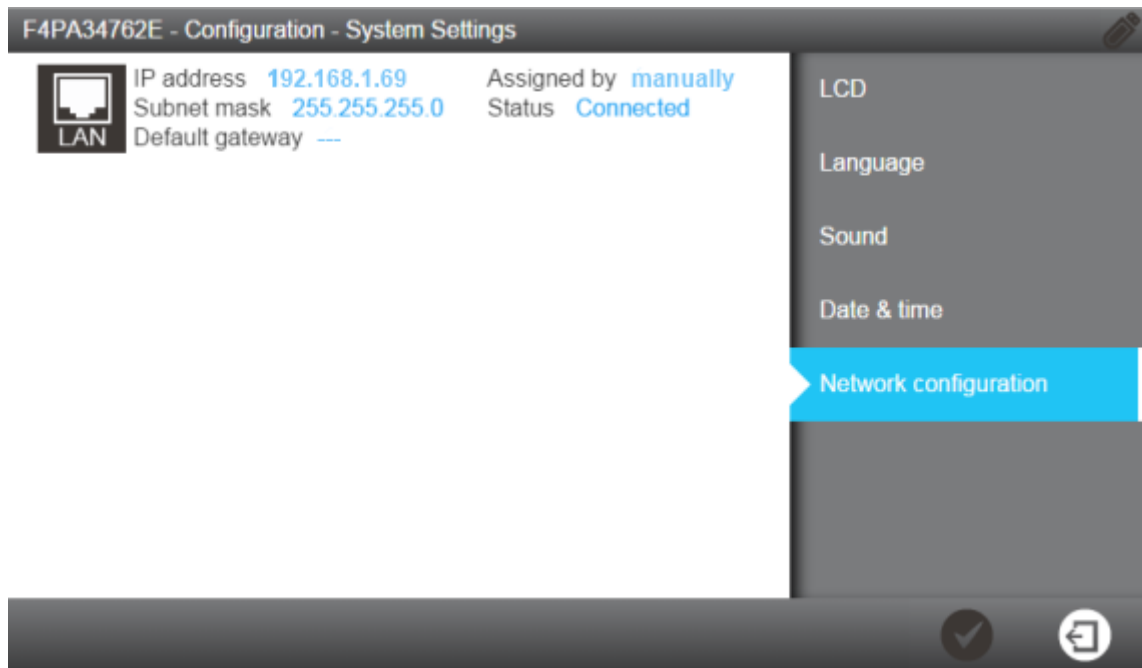

**Note:** This screen shows the default factory settings from the system LAN configuration.

3. Click on the LAN area of the screen to open the complete LAN configuration settings.

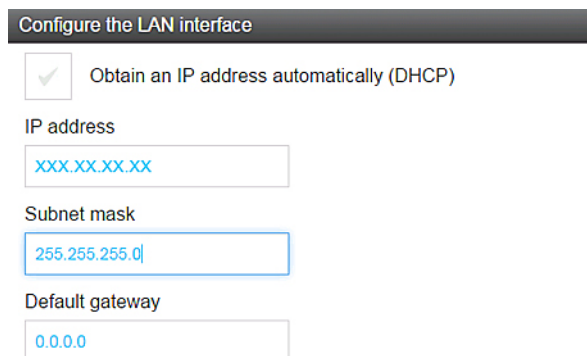

4. Enter the parameters corresponding to your configuration.

If you use DHCP mode, check the DHCP box. If using static mode you must complete the three fields:

- IP address
- Subnet mask, and
- Default gateway

using ip V4 format.

5. Validate your configuration by pressing the tick  icon.

Please confirm this action

Modify the network connection parameters of Ethernet interface

**New configuration**

DHCP:	Enabled
IP address:	192.168.1.69
Subnet mask:	255.255.255.0
Default gateway:	0.0.0.0

**Previous configuration**

DHCP:	Enabled
IP address:	192.168.1.69
Subnet mask:	255.255.255.0
Default gateway:	0.0.0.0



6. The Network configuration is changed and the display returns to the System Settings Application.

## **How to Power On and Power Off the Water System**

The water system has been designed to remain powered, this ensures the water quality in the system is maintained.

Water system backpanel view: (1) Power switch; (2) Power Outlet

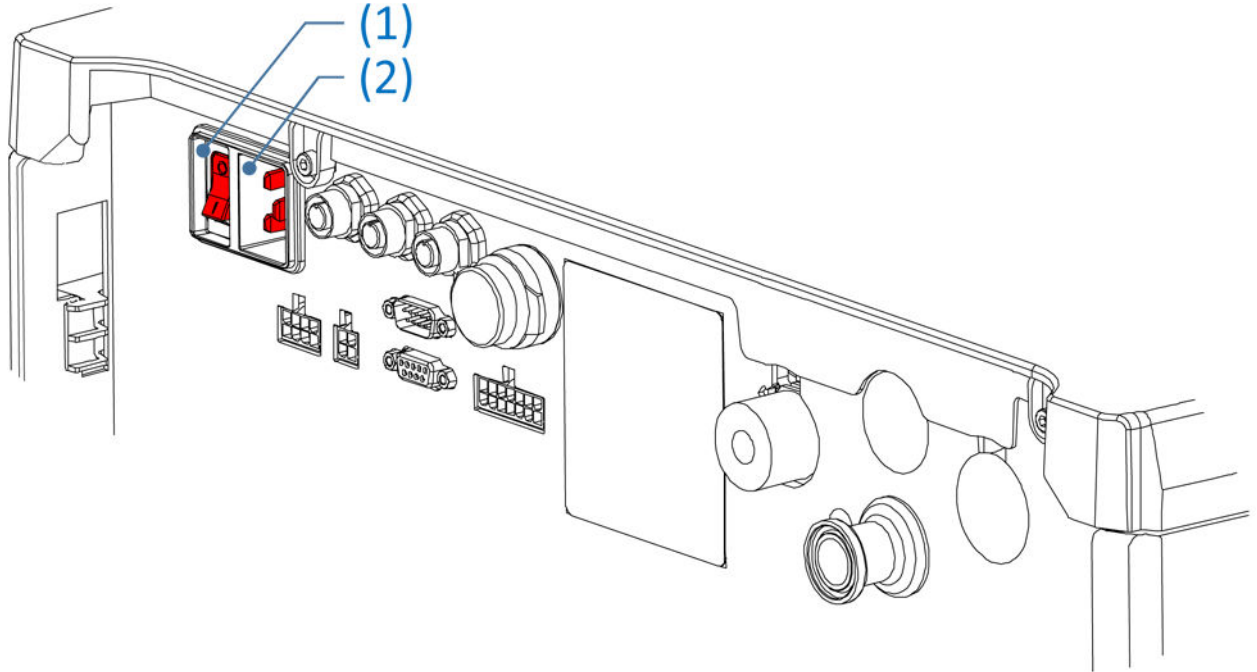

**Note:** Do not power off the system by removing the power cord from the **Power Outlet**.

If you need to power off the water system for any reason:

- 1.** Put the Makeup and Distribution processes into **Standby**.  
It is not recommended to shut down a running water system when operating (producing or dispensing water).
- 2.** Use the **Power Switch** to power off the water system.

## How to Use the Distribution Schedule

The **Distribution Schedule** application from the **Configuration** workspace allow you to program the distribution loop to fit your needs.

Depending on your production or system usage, you can affect a distribution behavior to each 1/2 hour of each day of a the week. The three distribution possible behavior are: Auto-recirculation, Recirculation and Tank Flush.

The distribution schedule can be configured, within 30 minute slots, to be in Auto-recirculation, Recirculation or Tank Flush.

1. From the **Configuration** workspace, open the **Distribution Schedule** application:



2. The **Distribution Schedule** application opens (*the bullet points in red will guide you throught the following steps*):

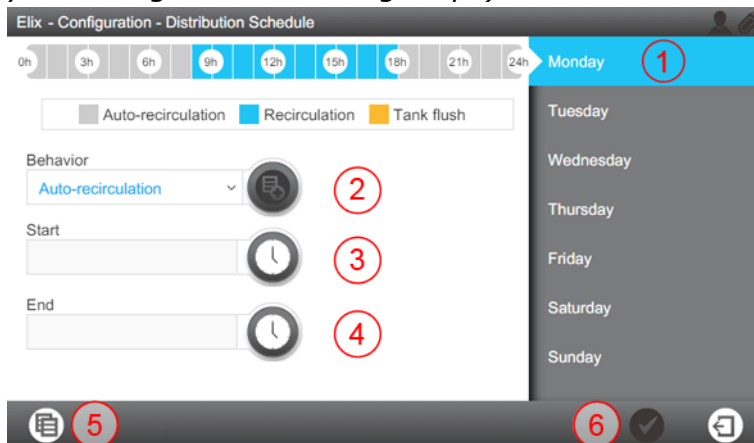

- a) Select one day of the week from the right side screen area (1).
- b) Choose the desired Distribution Schedule "Behavior" using a drop down list
- c) Program a start time to this behavior from field (3).
- d) Then program a end time (4) to this behavior.
- e) Each behavior has a start and a stop time which you can choose. After choosing these items, press the '+' button (2) to confirm your choices. You can see the result of this action at the top of the screen (0h .. 24h).
- f) When at least one slot of time has been completed, the save function (6) becomes white and allow you to save the scheduled slot of time.

g) Once a day has been completed, a "profile" day can be copied to another day of the week using the copy function (5).

Copy

From  
Monday

To

<input type="checkbox"/> Monday	<input checked="" type="checkbox"/> Friday
<input checked="" type="checkbox"/> Tuesday	<input checked="" type="checkbox"/> Saturday
<input checked="" type="checkbox"/> Wednesday	<input checked="" type="checkbox"/> Sunday
<input checked="" type="checkbox"/> Thursday	

X →

## How to Flush the Tank

---

**Prerequisite:** Put the Distribution processes into Standby (makeup process will be automatically stopped by the application)

1. From the **Maintenance** workspace, launch the **Sanitization & Cleaning** application and select Tank emptying (1).

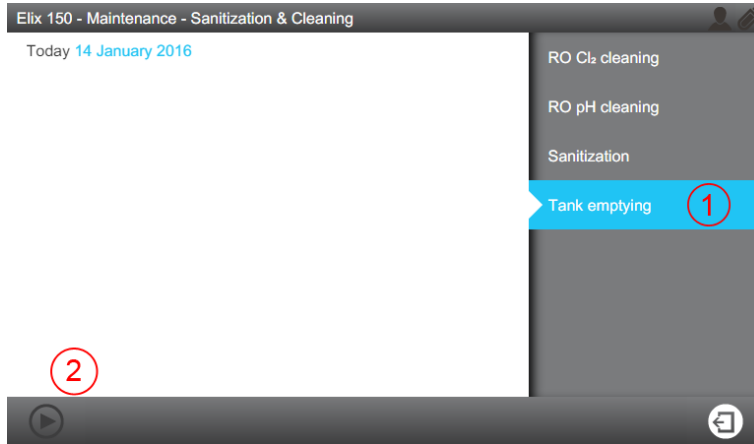

2. Launch the tank emptying function using the bottom left button (2).

**Note:** If the tank emptying button is disabled (grey), check if makeup and distribution processes are in Standby.



# Ordering Information

---

## Consumable Catalogue Numbers

### Packs and Filters

Label	Catalogue Number	Description
Progard® XL-S-C	PROGTXLCS1	Autoclean Qty 1
Progard® XL-S-C	PROGTXLCS2	Autoclean Qty 2
Progard® XL-S	PROGTXLOS1	Silver Impregnated Carbon - Qty 1
Progard® XL-S	PROGTXLOS2	Silver Impregnated Carbon - Qty 2
Opticap® XLT10 Durapore® 1/PACK	KVGLA1TTT1	0.22 µm 10" loop filter with 1½" tri-clamp connections
TANK VENT FILTER 2/ PACK	TANKVNT21	0.22 µm Air vent
TANK VENT FILTER 2/ PACK	TANKVNT22	0.22 µm Air vent, carbon and soda lime

### Cleaners

Label	Catalogue Number	Description
RO Protect C	ZWCL01F50	CL <sub>2</sub> tablets - Qty. 50
RO Protect C – USA only	5874316024	EfferSan CL <sub>2</sub> tablets - Qty. 24
RO Protect C – Canada only	5874316024C	EfferSan CL <sub>2</sub> tablets - Qty. 24
RO Care A	ZWACID012	RO Acid Cleaner - Qty. 12
RO Care B	ZWBASE012	RO Base Cleaner - Qty. 12

*Qty 1 refers to 1 unit per box.*

### Saniclean paks (Required tools for cleanings)

Label	Catalogue Number	Description
RO Regeneration Tool	ZLXLCLPAK	Required for all systems.
RO Regeneration plug/tool	ZLXLPLUGP	Required also for systems with two Progard packs.

# Accessory Catalogue Numbers

---

<b>Designation</b>	<b>Catalogue Number</b>	<b>Description</b>
Water Sensor (Main)	TANKLKXL1	Water sensor to be connected on system
Water Sensor	TANKLK002	Water sensor to be connected to other water sensors (Up to 3 water sensors connected in series)
External Valve	ZLXL00ESVSD	External solenoid valve
Degasser Kit	ZLXLDEGK2	Internal system option
External Pretreatment Cable	ZLXLPTCAB	Communication cable
Air Gap 2 inlets	AIRGAPXL2	For tubing internal diameter 10mm
Flow switch for pretreatment unit	ZLXLPTFSW	Flow drain switch for external pretreatment unit
Alarm Report Cable	ZLXLALCAB	Reports x2 alarms and x2 4-20 mA measures
External Pressure Regulator	ZLXL000PR	Feed water pressure regulator (0-25 bars)
UF Pretreatment Unit	ZUFPREUN0	Ultrafiltration filter Unit 3/4"
UF Installation kit	ZUFPREUN8	Installation kit for the UF Pretreatment Unit 3/4"
Resistivity kit high throughput	ZKITRES00SD	Resistivity and temperature measurement on distribution for HX SD
Resistivity kit & boost high throughput	ZKITRES01SD	Resistivity and temperature measurement on distribution including resistivity boost for HX SD
Resistivity boost & TOC high throughput	ZKITRES01T0CSD	Booster media and TOC measurement on distribution for HX SD
Support for Loop Panel Assembly kit	ZLXLSDL00PFEET	Feet for Loop Panel Assembly
Loop Panel Assembly Kit HX SD	ZLXLSDL00PKIT	Loop Panel Assembly to incorporate a loop filter or/and a 57W UV Lamp in the distribution loop
UV Loop kit 57W	ZLXLKITUV57	UV Loop kit that contains the UV housing, the UV lamp 57W, the gloves, the safety plug, the cables and the electrical box

Forced Distribution Option      ZLXLSDISCAB  
Cable

According to the distribution schedule, a system can be in idle mode with no possibility to distribute water. The Forced Distribution Cable enables to force the water distribution regardless of the distribution schedule

---

1.5 bar Check Valve Option      ZLXLSDCV15  
HX SD

The 1.5 bar optional check valve can replace the factory installed 1 bar check valve. Using the 1.5 bar optional check valve allows the distribution loop to deliver at a higher pressure (up to 2 bar). It does not change the distribution flowrate.

## System Catalogue Numbers

---

ZLXLSD720 40	Milli-Q® HX 7040 SD Water Purification System (HC) 100V 50/60 Hz
ZLXLSD620 40	Milli-Q® HX 7040 SD Water Purification System (HC) 120V 60 Hz
ZLXLSD520 40	Milli-Q® HX 7040 SD Water Purification System (HC) 230V 50/60 Hz
ZLXLSD710 40	Milli-Q® HX 7040 SD Water Purification System (LC) 100V 50/60 Hz
ZLXLSD610 40	Milli-Q® HX 7040 SD Water Purification System (LC) 120V 60 Hz
ZLXLSD510 40	Milli-Q® HX 7040 SD Water Purification System (LC) 230V 50/60 Hz
ZLXLSD720 80	Milli-Q® HX 7080 SD Water Purification System (HC) 100V 50/60 Hz
ZLXLSD620 80	Milli-Q® HX 7080 SD Water Purification System (HC) 120V 60 Hz
ZLXLSD520 80	Milli-Q® HX 7080 SD Water Purification System (HC) 230V 50/60 Hz
ZLXLSD710 80	Milli-Q® HX 7080 SD Water Purification System (LC) 100V 50/60 Hz
ZLXLSD610 80	Milli-Q® HX 7080 SD Water Purification System (LC) 120V 60 Hz
ZLXLSD510 80	Milli-Q® HX 7080 SD Water Purification System (LC) 230V 50/60 Hz
ZLXLSD721 20	Milli-Q® HX 7120 SD Water Purification System 100V 50/60 Hz
ZLXLSD621 20	Milli-Q® HX 7120 SD Water Purification System 120V 60 Hz
ZLXLSD521 20	Milli-Q® HX 7120 SD Water Purification System 230V 50/60 Hz
ZLXLSD721 50	Milli-Q® HX 7150 SD Water Purification System 100V 50/60 Hz
ZLXLSD621 50	Milli-Q® HX 7150 SD Water Purification System 120V 60 Hz
ZLXLSD521 50	Milli-Q® HX 7150 SD Water Purification System 230V 50/60 Hz





















# Appendix

---

## Display Icon Description



---



Icon	Function
	Exits the current application or wizard.
	Navigates back to the previous screen.
	Navigates forward to the next screen.
	Cancels an action.
	Confirms an action.
	Adds a new item to a list.
	Removes the selected item(s) from a list.
	Modifies the selected item(s) of a list.
	Opens the Glance Workspace.
	Opens the Maintenance Workspace.
	Opens the Configuration Workspace.
	Shows water quality measurements.
	Shows hydraulic parameters.
	Shows electrical parameters.
	Starts a software wizard.
	Opens a consumable override wizard.
	Filters the data.
	Exports the data.
	Automatically fills a field with the system date.
	Time setting
	Copy schedule

Icon	Function
	Add selection to schedule

The system buttons used are virtual icons on the display and their **status** is determined by colour.

	Disabled.
	Enabled.
	Pressed or selected.



### Peripherals and communication indicators:

On each of the MMI screens, on the top right, there are two icons to indicate the connection status, via Ethernet or the front side USB port.





As an example for the Overview screen:



### USB port (front side):

	No USB device detected on the system.
	A USB device has been inserted and detected by the system.

### Ethernet connection status:

	<p>No effective network connection has been established.</p>
	<p>An Ethernet connection is active on the system. At this time, up to 3 different IP address can be connected to <b>view</b> the general operation of the System.</p>
	<p>Via the Ethernet connection, someone is remotely using the <b>Maintenance</b> and/or <b>Configuration</b> applications on the System. The IP address is shown. At this time, no one else can access the <b>Maintenance</b> and/or <b>Configuration</b> applications. To gain access at this time via the Ethernet connection, ask the user having the remote IP address to leave the <b>Maintenance</b> and/or <b>Configuration</b> applications.</p>
	<p>A user is using the MMI directly and is in the <b>Maintenance</b> and/or <b>Configuration</b> applications. At this time, no one else can access the <b>Maintenance</b> and/or <b>Configuration</b> applications. To gain access at this time, via the Ethernet connection, ask the user (in front of the system) to leave the <b>Maintenance</b> and/or <b>Configuration</b> applications.</p>

## System Operating modes

This chapter describes the various process states of Makeup and Distribution processes.

When not in standby, the different modes possible within the Makeup and Distribution processes are described below.

**Table 3: Makeup Ready Modes**

Makeup Mode	Use
INITIALIZATION	To check and reset components.
READY	Pauses the Makeup process when the tank is full.
FLUSH	To periodically sweep away contaminants on the feedwater surface of the RO Membrane.
RINSE	To prevent poor quality water reaching the Elix® Module before TANK FILLING.
TANK FILLING	To fill the Tank.
AUTOTEST	Checks internal components.
PROGARD FLUSH	To flush new Progard® Pack(s).
RO RINSE	To rinse new RO Membrane(s).
CL <sub>2</sub> CLEANING	To clean RO Membrane(s).
pH CLEANING	To clean RO Membrane(s)
REAGENT REMOVAL	To remove cleaning agents after CL <sub>2</sub> CLEANING or pH CLEANING.
ALARM STOP	Stops the Makeup process in the event of an Alarm Stop signal.
BACKWASH FILTER REGENERATION	Pauses the system whilst a backwash filter regenerates.

**Table 4: Distribution Ready Modes**

Distribution Mode	Use
READY	To get the distribution process operating in one of the different modes: Recirculation, auto-recirculation or schedule.
RECIRCULATION	To maintain water quality.
TANK FLUSH	To maintain water quality when tank is full.
ALARM STOP	To stop the Distribution process in the event of an alarm stop signal.
TANK EMPTYING	To empty the tank.

**Note:** When the system is powered on, it returns to the mode operating when the system was powered off. For example, if the system was in Makeup **TANK FILLING** then it returns in Makeup **TANK FILLING**; and in Distribution **RECIRCULATION** then it restarts in Distribution **RECIRCULATION**.