

Multi-Column Capture

Prototype Tests for Monoclonal Antibody Capture During Project nextBioPharmDSP (Horizon 2020)¹

Merck Authors: Damien Kervennic, Project Manager Downstream Processing, Cindy Delagrée, Global Product Manager, Continuous Downstream Processing, Integrated Systems

Lek Author: Gorazd Hribar, Dep. Head in Bio. Production, DS BioProduction Mengeš, Novartis Technical Operations—Biotechnology

Introduction

There is a growing acceptance of, and demand for, biopharmaceuticals for their ability to treat previously untreatable diseases. This increased need is impacting important business drivers including the cost of downstream processing (DSP), flexibility, and the speed with which new products can be brought to market. In response to these business drivers, manufacturers, consortia, and government bodies are investigating strategies to optimize downstream bioprocessing.

One such effort within the European Union’s “Horizon 2020” initiative is the “Next Generation BioPharmaceutical Downstream Process” (nextBioPharmDSP) innovation project. This project was tasked with implementing a fully-integrated downstream continuous manufacturing platform utilizing single-use disposable technologies. The goal is to meet market needs in three main areas: cost reduction, production efficiency, and speed to market.

Continuous processing and single-use technologies have been proposed to address these challenges through increased productivity, reduced capital expense, and increased product quality. Process flexibility is addressed through the implementation of single-use technologies, which eliminates potential carry over issue when moving between products and additionally reduces bioburden risks. Lastly, continuous processing and single-use technologies increase speed to market by enabling clinical product scale to become the final manufacturing scale by changing the scale-up to a scale-out paradigm, further eliminating transfer risks.

In this study, single-use technologies and advanced analytical tools were evaluated. One key component of this process is the integration of continuous capture chromatography. Result from the multi-column capture (MCC) system developed and utilized for this project are reported here.

Traditional Approach

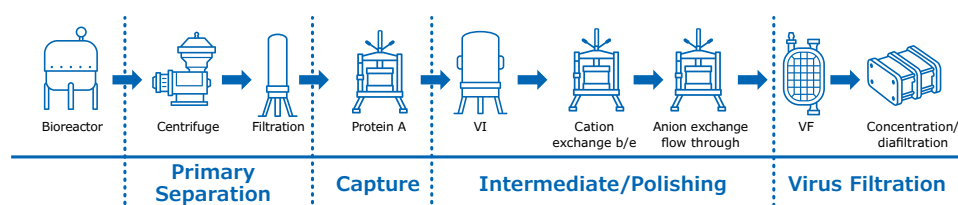

New Process

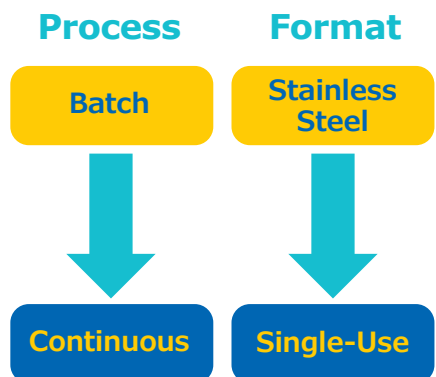
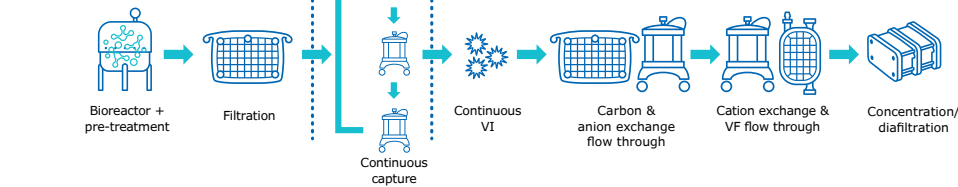
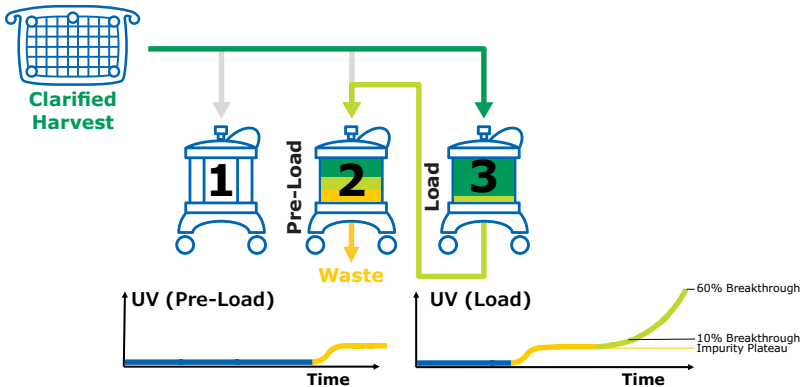
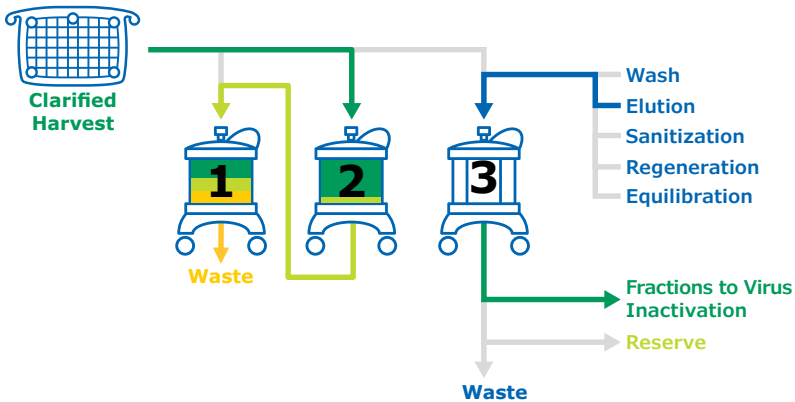

Figure 1: Continuous capture process

2a



2b



2c

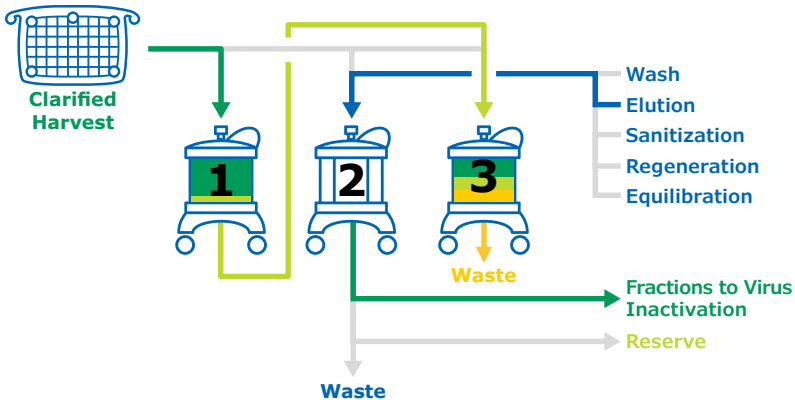

2d

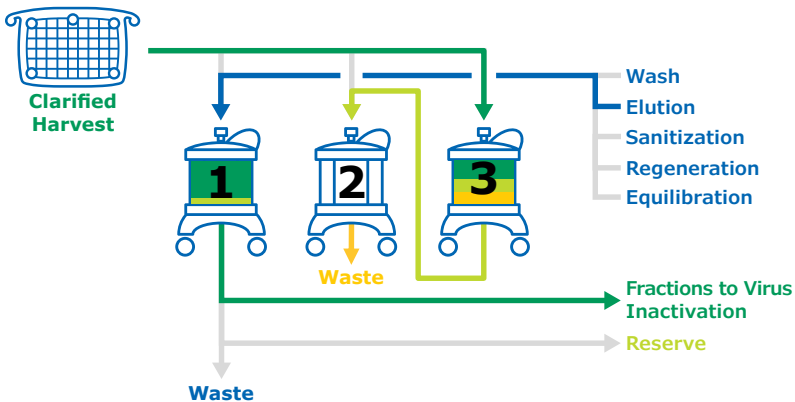

Figure 2: Continuous cycle description

Continuous Capture Process

In a standard batch operation, the dynamic binding capacity (DBC) of a capture column is traditionally determined during development as 10% of breakthrough (BT) of the product. In manufacturing, the column is then loaded to 80–85% of this DBC (which corresponds roughly to 60–70% of resin utilization). All operations (loading, washing, elution, etc.) are performed on a single column, that usually has a 20 cm bed height (BH). Under these conditions, only the first part of the column is used and there is a gradient of protein concentration from the top to the bottom of the column. To improve the resin usage, the column was replaced by 2 smaller columns connected in series.

The previous operation was repeated, this time instead of one column of 20 cm BH, 2 columns of 10cm BH were used. The same quantity of protein was loaded on 2 columns set in series. The breakthrough curve was monitored after the first column. The end of the loading of a given quantity of product (same than the quantity loaded in batch mode) can roughly meet a BT of 60%, which represents about 90% of the resin utilization (instead of 60–70%). Thus loading 2 columns set in series instead of one column, allows maximized resin usage.

This led to the introduction of continuous chromatography where at least three columns are operated simultaneously. As shown in figure 2, once column 3 is loaded (figure 2a), it is disconnected from column 2 to be washed, eluted and regenerated (figure 2b). At the same time, column 2 (already partially loaded) is set in series with column 1 that is still unused and ready to accept product load.

When column 2 is loaded, it is then disconnected from column 1 for wash, elution, and regeneration (figure 2c). The same procedure is repeated with column 1. This complete sequence is called a cycle and can be repeated as many times as necessary to process all material or until the defined maximum number of cycles is reached on the chromatography resin.

For a given product quantity, columns loaded in series are better utilized (90% utilization) than in batch mode (60–70% resin utilization). These columns can be recycled up to the complete lifetime of the resin, leading to smaller volumes required, at higher DBC than in a batch mode. This reduces costs while fully maintaining the performance and robustness of capture chromatography purification.

System Description

A custom designed multi-column capture system was used. Features include:

- Fully-automated single-use system
- 3-column operation with diameters from 7 to 25 cm (8 to 120 L/h per line, could be extended to 150 L/h)
- 2 zones (3 product inlets, 6 solvent inlets)
- Common Control Platform® Software Interface V 6.0 (figure 3)
- Elution peak detection through UV280 nm or other UV
- Protein breakthrough detection through UV shift
- Capability of external PAT for additional process parameter attributes

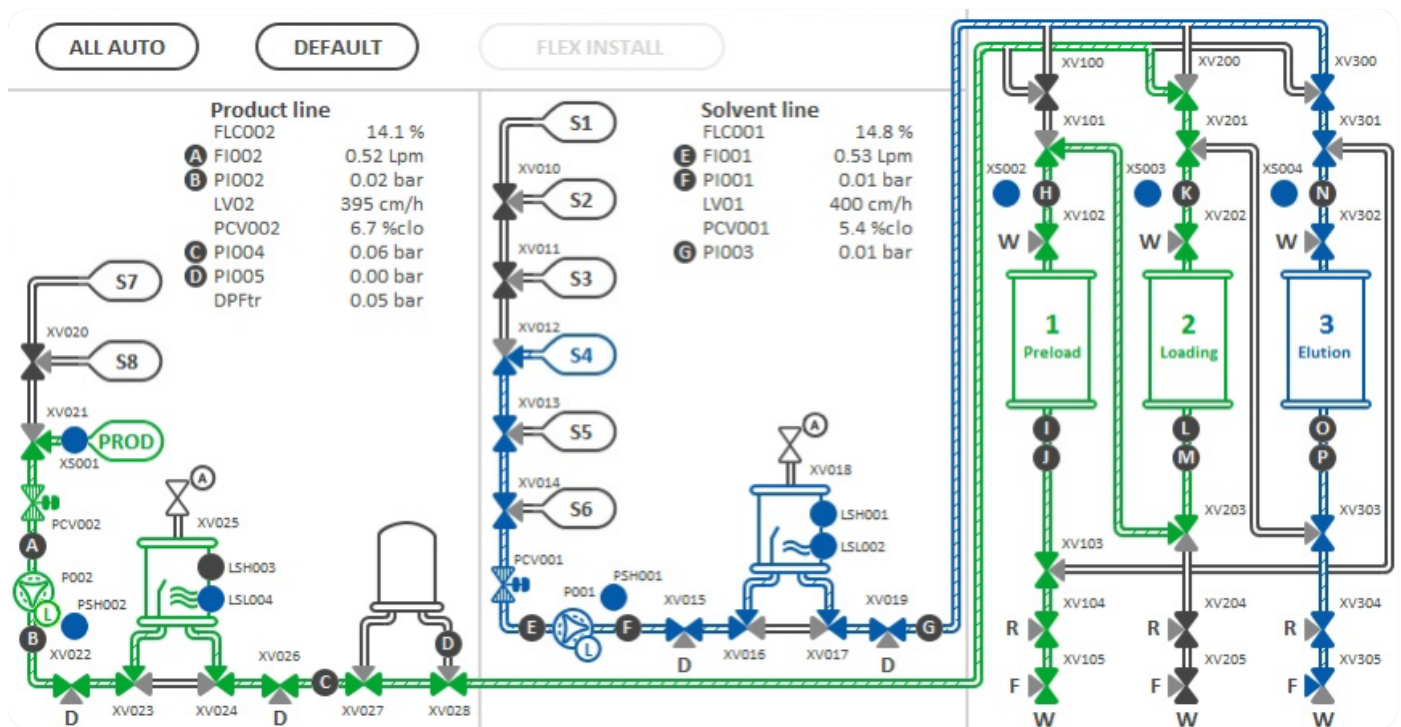

Figure 3: Common Control Platform® Software Interface V 6.0

Test Summary

Proof of Concept Testing—Whey Protein Capture

M Lab™ Collaboration Center, France

Objective

Evaluate and optimize system performance for continuous processing at manufacturing scale. Evaluate and optimize system performance for continuous, 24h operation without interruption and automated column switching.

Materials and Methods

Five runs were performed. For load material, 650 L of whey mixture (mix of milk proteins) was prepared with purified water, sedimented, 0.2 µm filtered and loaded onto three pre-packed columns containing the strong cation exchange Fractogel® SO₃ resin with 10 cm bed height and diameter.

This proof of concept was performed for three cycles (per column) during 24 hours at a flow of 17 L/h.

Results and Conclusions

Figure 4 shows the regular switch between columns over three cycles in 24 hours, without any interruption. This figure shows an irregularity in the first three elution peaks (*); it corresponds to the initial loading phase, which is not representative of the continuous cycle (pre-loading is missing). This is followed by repetitive regular elution peaks as expected in a continuous mode.

This run demonstrates successful and effective continuous processing for 24 hours including automated column switching.

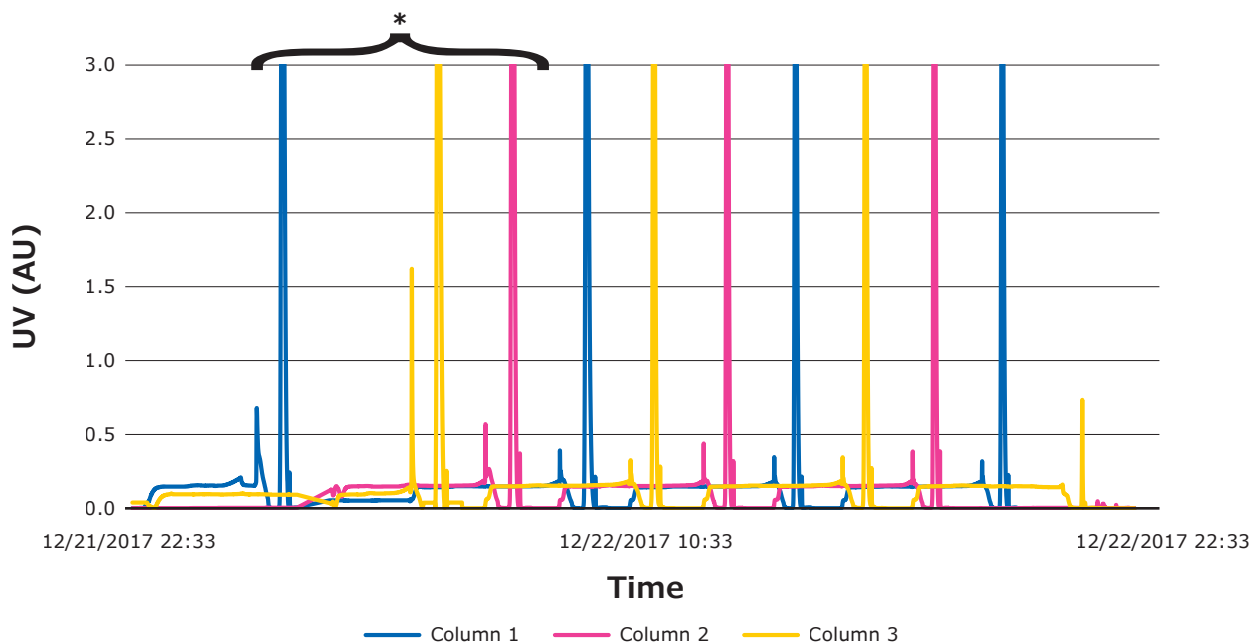

Figure 4: Chromatogram of continuous run over 24 hours

Integration Into a Continuous Downstream mAb Process

Runs at End User Facility

Objective

The objective was to connect a complete downstream process and to run continuously in order to demonstrate benefits such as reduced costs, increased productivity, and lower environmental impacts. This was proven by executing four validation runs at 1000 L bioreactor scale with mAb. The objective of the capture step was also to demonstrate the possibility to capture mAb continuously and robustly with the multi-column capture system.

Materials and Methods

Monoclonal antibodies were produced in a 1000 L bioreactor, operated in fed-batch mode. Cell culture harvest was pre-treated with pDADMAC[®] cationic polymer flocculant and clarified through Clarisolve[®] 40MS depth filters followed by Millipore Express[®] SHC sterilizing-grade filter. This clarified pool was continuously loaded onto Protein A Resin (3 x 0.55 L, 10 cm Ø x 7 cm BH) utilizing the multi-column capture system at an average flow rate of 0.28 L/min for 2.5 days. The elution peaks were continuously sent to viral inactivation. The viral inactivation skid (VI) was composed of 3 L single-use tanks with the capacity to continuously decrease the pH, hold the solution for the desired time, and re-adjust the pH prior to polishing. Product was then polished in flowthrough mode and sent to subsequent operation. All continuous operations were performed using interconnected systems in order to trigger process actions and send feedback alarms in case deviation occurred. These interconnections are represented by figure 5. Post-column UV sensors triggered the switch between loading columns based on a breakthrough detection and the switch between waste and fraction during elution peak detection. A valve was installed on the inlet of the virus inactivation skid to divert fractions to one tank or another based on these tank levels. Feedback alarms such as tank overloading could be sent back to interrupt the multi-column capture system. The level of the last tank of the inactivation skid was controlling the start of the polishing chromatography systems.

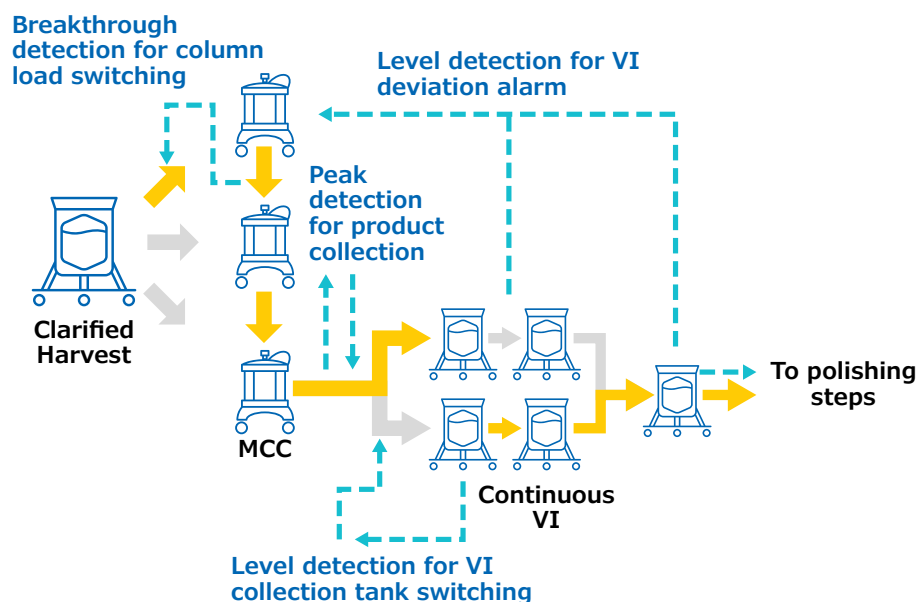

Figure 5: System interconnections during nextBioPharmDSP engineering runs

Results and Conclusions

Through the validation runs, it was possible to consistently process kilogram quantities of mAb on the multi-column capture system run after run by optimizing operational parameters of the complete DSP suite. We ran approximately 30 cycles per column during the first three runs and 46 cycles during the last run for a total of 146 bind/elute operations. Table 1 shows the parameters and results of the different runs.

Data		Run 1	Run 2	Run 3	Run 4
Number of cycles	Total	90	92	94	139
	Column 1	30	30	32	46
	Column 2	30	31	31	46
	Column 3	30	31	31	47
Loading speed (cm/h)		180	240	210	210
Elution speed (cm/h)		180	280	280	280
Loaded quantity (L)		764	783	854	871
mAb concentration (g/L)		4.10	3.79	3.69	3.69
mAb loaded (g)		3132	2968	3149	3214

Table 1: Parameters and results of engineering runs

Detailed MCC Performance for Validation Runs

The fourth validation run had the greatest number of cycles, and the results are reviewed in this section. During this run, the continuous capture was performed on protein A columns over 46 cycles during more than 2 days. UV spectra related to each column are shown in figure 6a-c, with overlaid spectra for all three columns (figure 6d) indicating consistent performance throughout the 139 bind/elute operations. As in the proof of concept and as expected, the first cycle is irregular, followed by regular and reproducible peaks. One short interruption was observed (*), linked to a pause triggered from the following step (virus inactivation) and connected to the alarm for tank level. Apart from that, no other interruption was observed.

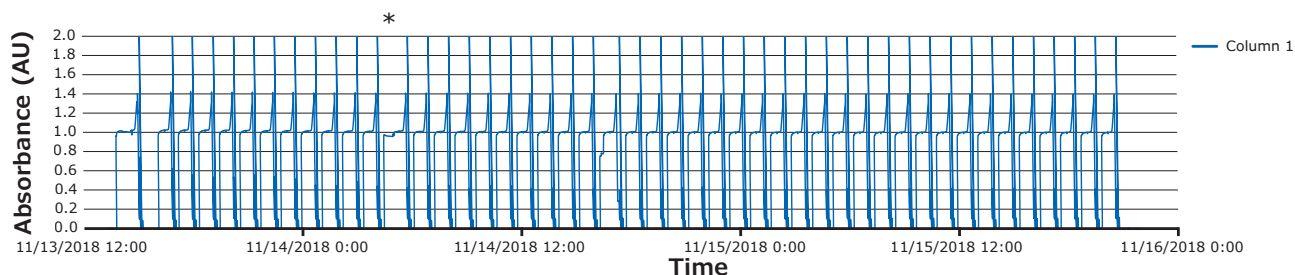

Figure 6a: Chromatograms of the fourth validation run, column 1

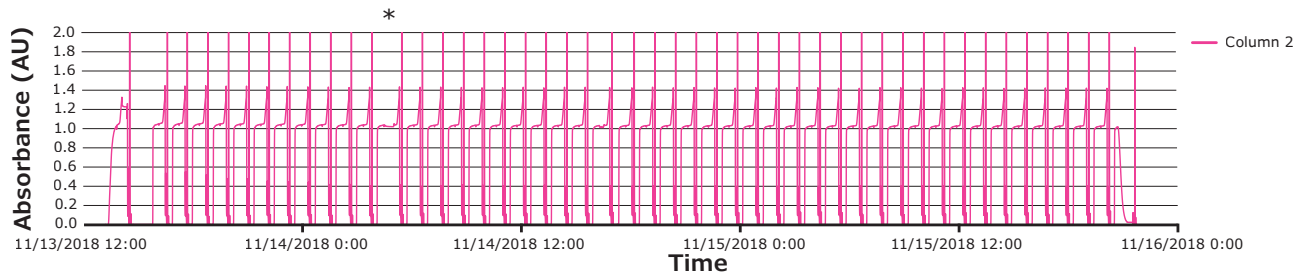

Figure 6b: Chromatograms of the fourth validation run, column 2

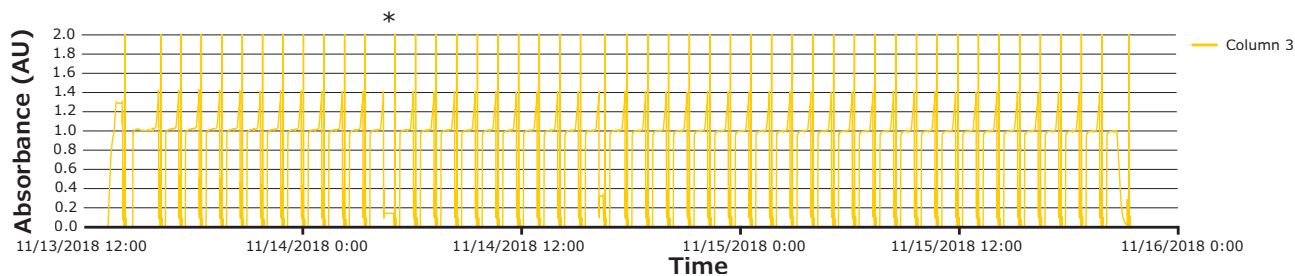

Figure 6c: Chromatograms of the fourth validation run, column 3

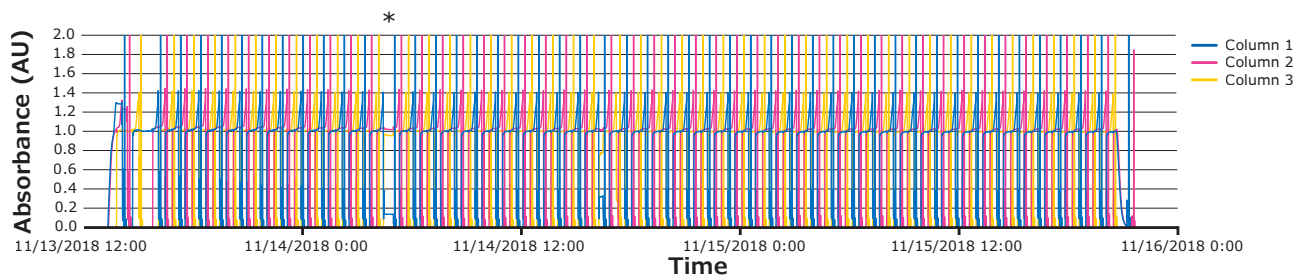

Figure 6d: Chromatograms of the fourth validation run, column 1, 2, and 3

The defined BT percentage corresponds to the difference between the impurity plateau and maximum UV value of the clarified harvest (figure 7). Figure 8 illustrates the UV signals of the impurity plateau (dots) and breakthrough (squares) triggering the column switch on the continuous capture system throughout the 139 cycles of the fourth validation run. On the graph, two trends can be observed. The dots indicate a stable absorbance during loading, corresponding to impurities coming out of the column being loaded. The squares on the graph represent the absorbance (of product and impurities) at each cycle and correspond to the switching value absorbance between columns when the defined breakthrough is reached. During this project the switching value used was 60% of the BT. Figure 8 shows an extreme regularity of the level of impurity plateau and breakthrough detections cycle after cycle, with a standard deviation below the accuracy of the sensor (table 2), demonstrating that performance across different cycles throughout the process was very consistent and comparable.

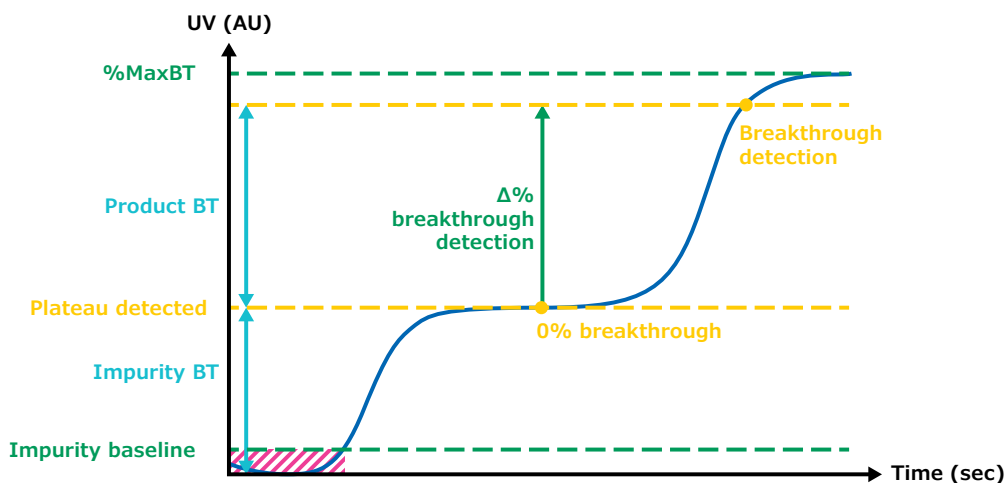

Figure 7: Breakthrough detection

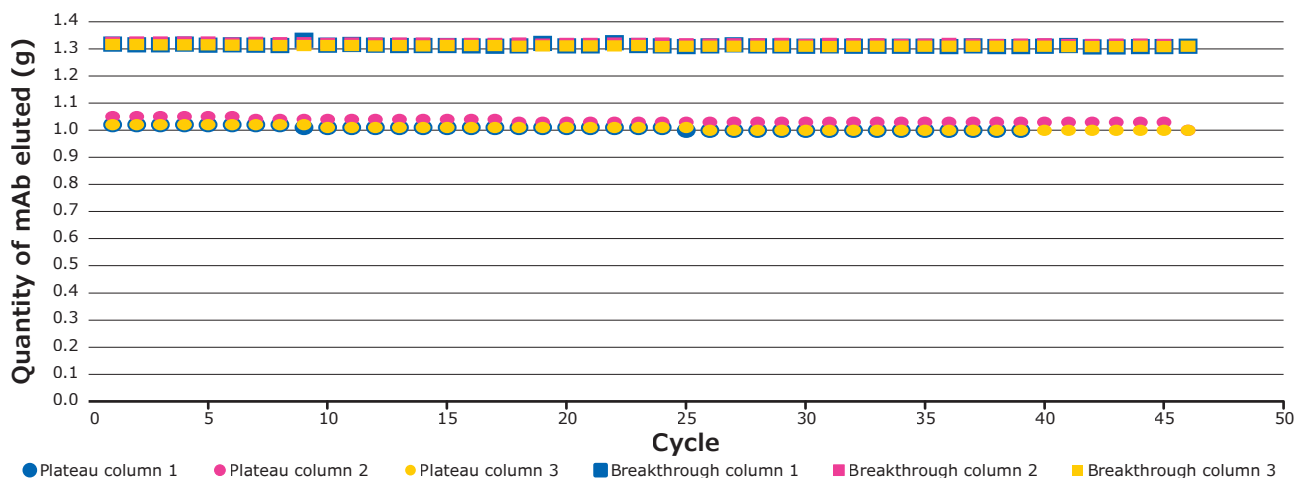

Figure 8: Plateau and breakthrough levels during the fourth validation run

Column	Impurity Plateau (AU)		Breakthrough (AU)	
	Average	Standard deviation	Average	Standard deviation
1	1.007	0.007	1.312	0.004
2	1.035	0.007	1.320	0.003
3	1.007	0.008	1.311	0.002

Table 2: Impurity Plateau and breakthrough detection during validation runs

Process Implementation Perspectives

This report exhibits the utility of an automated multi-column capture system for the continuous purification of 1000 L of cell culture harvest containing 3.2 kg of mAb over 55 hours to enable continuous manufacturing and lower costs of goods.

Figure 9 compares several scenarios for mAb capture in batch mode (1 column) or using the multi-column capture system.

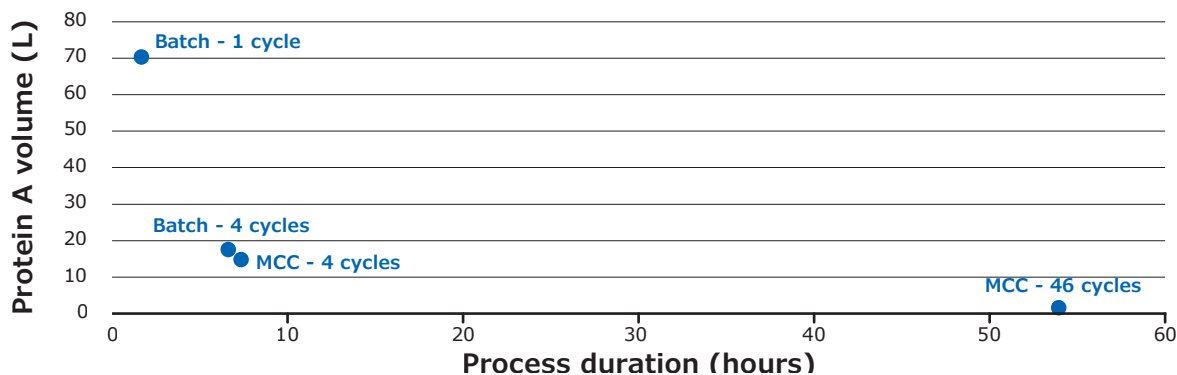

Figure 9: Different scenarios for purifying 3.2 kg of mAbs

Using the MCC system, the volume of protein A required could be reduced by up to 43 times compared to batch mode with a single cycle. The productivity is increased from 30 g_mAb/L_resin/h for batch mode to 40 g_mAb/L_resin/h for 46 cycles with the multi-column capture system. With the MCC system it is also possible to purify up to 3000 L of mAb at 4 g/L in 24 hours.

Conclusion

Next-generation processing aims at reducing costs, increasing mAb titers, and improving productivity and can be addressed by implementing a continuous capture step on a multi-column capture system. As reported here, such a technology considerably reduces the volume of protein A resin required, and thus, the cost. This continuous technology, combined with the benefits of single-use equipment, increases mAb productivity, reduces plant footprint, lowers facility investment, improves plant flexibility, and reduces risk to product.

Acknowledgements

[1] This work has received funding from the European Union's Horizon 2020 research and innovation program under grant agreement No. 635557.

For additional information,
please visit SigmaAldrich.com/chrom-systems

