

safety connects.

Your direct connection to maximum safety in daily solvent handling.

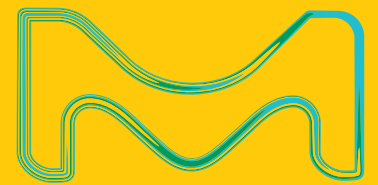

The life science business of Merck KGaA, Darmstadt, Germany operates as MilliporeSigma in the U.S. and Canada.

Supelco[®]
Analytical Products

Solvent management systems

We invest heavily in safe and innovative solvent handling technology and product development, focusing on customer requirements and offering a wide range of products and accessories. Our primary goal is to ensure user safety and the reliability of analytical results in your laboratory.

For many years, we have worked closely with customers to develop solvent withdrawal systems that are tailor-made according to solvent grades and packaging types.

Today, our broad range of withdrawal systems and containers is unrivaled in the industry. As a result, customers are assured that, whatever the application is, we can supply an integrated solution with the right solvent grade in the right container and with the right withdrawal system for highest safety and optimal results.



Table of Contents

pages

All you need for your individual application	04 – 05
Pack size recommendation	06 – 07
Safety and protective features	08 – 09
Service & Support	10 – 11

Packaging properties, Withdrawal systems & Installation options

Bottles	12 – 19
Drums	24 – 35
Barrels	36 – 45
Containers	46 – 47

Safety Accessories

Safety accessories for bottles	20 – 23
Safety accessories for barrels & drums	48 – 49
Level sensors	50 – 51

Customized installations 52 – 53

Ordering information & product pictures 54 – 59

Useful technical tables

Withdrawal system suitability	60 – 61
Connections for barrels & drums	60 – 61
Tubings	62
Bottle connections	63

All you need for your individual application



Glass bottles
0.5 L - 4 L

Page 14



Aluminum bottle
5 L

Page 18



Stainless steel barrels
10 L - 185 L



Pages 36-39



Other barrels and containers
≥ 1,000 L



Page 46



Glass bottles
0.5 L - 4 L

Page 14



Stainless steel barrels
10 L - 185 L



Pages 36-39



Instrumental analysis

Uvasol®..... Spectroscopy

SupraSolv®
UniSolv™ Gas chromatography

MagniSolv® NMR spectroscopy

LiChrosolv® HPLC

Preparation & Purification

Solvents for DNA & peptide synthesis

Prepsolv®..... Solvents for preparative chromatography

► Pack size recommendation and return system
Turn the page for more detailed information on packaging sizes.

Classical analysis and synthesis

EMSURE® Solvents for analysis
ACS, ISO, Reag. Ph Eur

EMPARTA® Solvents for analysis ACS

EMPLURA® Solvents for lab applications



Glass bottles
0.5 L – 4 L

Page 14



HDPE bottles
1 L – 5 L

Page 16



Aluminum bottles
5 L

Page 18



Stainless steel drums
10 L – 190 L

RETURNABLE PACKAGING

Pages 24-27



Other drums and containers
10 L – ≥1,000 L

ONE-WAY PACKAGING

Page 32

Other barrels and containers
≥ 1,000 L

Page 46



Fully sealed stainless steel barrels
10 L – 30 L

RETURNABLE PACKAGING

Page 39



Stainless steel drums
10 L – 190 L

RETURNABLE PACKAGING

Pages 24-27

Pack size recommendation and return system

We have a strong track record in developing practical and safe packaging concepts and chemical packaging that preserve the high quality of our solvents. We have been authorized as an official inspection authority by the Federal Institute for Material Research and Testing of Germany (BAM).

Our unique variety of packaging sizes and types for organic solvents provides a solution for each of your individual applications.

Pack size recommendation

Bottles



Metal drums



Stainless steel drums & barrels



Pack sizes

0.5 L – 5 L

10 L – 190 L

Annual consumption

0.5 L – 100 L

100 L – 1,000 L

Standard packaging

Standard packaging range **one-way packaging**

Stainless steel drums **optionally returnable packaging**

Stainless steel barrels **mandatorily returnable packaging**

- Advantage: no rinsing / cleaning / disposing
- Return unrinsed with original labels and tightly closed

Intermediate bulk containers (IBC) Tank trucks



190 L – 20,000 L

> 1,000 L

Stainless steel containers **mandatorily returnable packaging**

- Customized products and containers
- Individual processes with rental agreements

Return system

Stainless steel barrels and drums are part of a return process. The reuse of barrels and drums makes it possible to conform to packaging regulations that require packaging waste to be reduced or even avoided. In this way, supplier and user act together in a partnership in reducing packaging waste.

Return system chart

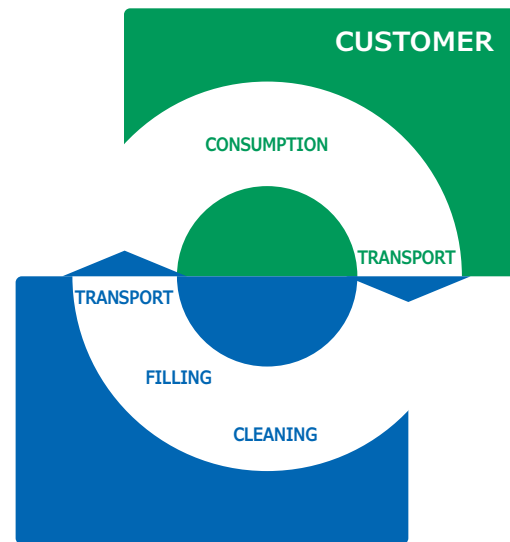

Stainless steel barrels and containers are mandatory to be returned and are coded with a unique ID number – **mandatorily returnable packaging**.



Stainless steel barrels and containers are mandatory to be returned and are coded with a unique ID number – **optionally returnable packaging**.



Metal drums are used as **one-way packaging**.

Safety and protective features

Packaging must meet or exceed minimum performance standards given by the specifications of the United Nations before it can be authorized for the carriage of dangerous goods. If they pass the test, the packaging becomes a design-type, certified by a national competent authority. Coded with a unique marking it is easy for our customers to read important safety advantages directly.

UN 1A1/X2.3/900/99/D/BAM8361-TCS

- UN** United Nations Packaging Symbol
- 1** Drum
- A** Steel
- 1** Non-removable head
- X** For packaging groups I, II and III
- 2.3** With a relative density of 2.3 and a vapor pressure of max. 230 kPa
- 900** Hydrostatic test pressure in kPa (900 kPa = 9 bar)
- 99** Year of manufacture = 1999
- D** Origin of manufacture = Deutschland (Germany)
- BAM8361** Approval authority with unique registration number (= 10 L barrel of Merck KGaA, Darmstadt, Germany)
- TCS** Manufacturer code

Specially shaped barrel top section for safe stacking and usage



Flexible withdrawal system with inert gas pressurizing for stainless steel barrels and drums



Engraved identification number for complete monitoring of the barrel (e.g. automatic stop for safety test, tracing)



UN approved packaging for safe transport of dangerous goods



Specially developed screw-cap for tight closure without leakage and contamination



Variety of bottles in different materials and sizes for your individual demand

Design improved drum top with engraved UN code for safe stacking and usage



Manual withdrawal system for safe flexibility for all barrels and drums of 10, 25 and 30 L volume



Specially shaped bottom section of drums and barrels for optimal emptying of residues

Fire triangle and static electricity

If flammable liquids (e.g. solvents) are to be used, the container (10 L and more) must be properly earthed according to valid safety regulations to avoid explosion and fire risks. Appropriate measures must be taken to discharge static electricity. General warnings and safety instructions must be observed, they reduce the risk of electrostatic separation of charges to increase safety in daily solvent handling dramatically.

Oxidizer

Planned introduction of air, inadvertent introduction of oxygen, release of hydrocarbons into air, weathered fluids, oxidizers

Ignition source

Heat, electricity, static electricity, friction, chemical reactions, spontaneous combustion, dieseling, pyrophors, sudden decompression, catalytic reactions

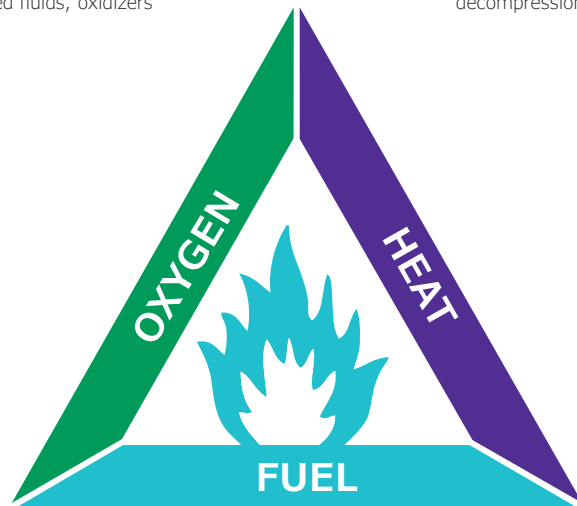

Heavy and light gases, hydrocarbon liquids and vapors, vapors of chemicals / lubricants / solvents, frac oils, flammable materials

Safe handling with our protective features

- ▶ Earthing with an antistatic device
For further information please have a look at page 48.
- ▶ Using a fume hood
More details on page 42.

Service and support

Merck creates sustainable value and provides a wide range of customized services to meet your individual requirements.

We have extensive experience in handling all types of hazardous materials, including highly sensitive substances in specially developed packaging with directly connectable, safe withdrawal systems.

Please make use of our various information platforms as well as of our customized service and support for your individual lab environment and application.



Our websites

Please visit our solvents websites:

[MerckMillipore.com/solvents](https://www.merckmillipore.com/solvents)

[SigmaAldrich.com/classical-lab-chemicals](https://www.sigmaaldrich.com/classical-lab-chemicals)

for additional product information.





Technical details

Our withdrawal systems include comprehensive manuals with safety and handling instructions. Additionally all installation steps are described with many pictures to provide maximum safety in daily solvent handling.

Please contact your local Merck agent for additional information on the ordered products.



Online Media

Please visit our special withdrawal system websites for additional product information on withdrawal systems, handling videos and important safety topics in daily solvent handling.

Withdrawal systems:
MerckMillipore.com/solvents-withdrawal
Safety film & handling video manuals:
MerckMillipore.com/safety-film



Technical drawings

Please contact your local Merck agent for technical drawings of your individual installation or on products of interest.

Print Media

Information on solvents and accessories can also be found in our solvents catalogue. "Accuracy you can count on" (order no. W282105). Please ask your local Merck supplier for a printed copy or visit us at **MerckMillipore.com/solvents-literature** for pdf download.



Safety, regulations & requirements

Please visit our website **MerckMillipore.com/safety** for questions concerning your lab safety, e.g. basic lab rules, safety data sheets or safe storage.

Bottles – a large variety for every need

Merck's demanding quality standards apply not only to the reagents themselves but also to the packaging they are supplied in; each material being carefully developed and matched to its product specification. Our extensive variety of packaging types and sizes is unrivaled in the industry. Each of your individual demands can be covered with bottle pack sizes from 0.5 L to 5 L and materials from glass with and without septum lids to HDPE and aluminum.



Glass bottles | pages 14 – 15

- Safe and convenient handling, storage and transportation – use our available safety accessories
- S40 thread with special shape for safe pouring
- S40 screw cap with tamperproof seal
- High pressure resistance
- Premium amber blank glass suitable even for aggressive chemicals
- Pulp packaging (molded fiber trays) for safe transportation of glass bottles



HDPE bottles | page 16

- Made from high-density polyethylene (HDPE)
- No risk of fracture – cost reduction by avoiding additional packaging material
- Safe and convenient handling by large integrated handle or available pouring aid (for 1L)
- Low tare weight facilitates handling and reduces transport costs
- S40 thread with special shape for safe pouring
- S40 screw cap with tamperproof seal
- High pressure resistance



Withdrawal systems

Take advantage of perfectly matched systems for maximum safety in your individual application.

- ▶ Manual withdrawal system | pages 23-24



Aluminum bottle | page 18

- No risk of fracture – cost reduction by avoiding additional packaging material
- Safe and convenient handling by integrated pouring ring
- Low tare weight facilitates handling and reduces transport costs
- S40 thread with special shape for safe pouring
- S40 screw cap with tamperproof seal
- High pressure resistance

All about ...

Safety accessories for bottles

| pages 20-23

Handling hazardous goods daily demands highest health protection. Specially for solvents in glass bottles there are several additional safety products available that increase your laboratory safety dramatically.

Amber Glass bottles

[available from 0.5 L up to 4 L]



- + **Withdrawal system** for bottles | pages 22-23
- + **HPLC adapter** to connect bottles directly to HPLC instruments | page 21
- + **Adapter** to connect equipment with different thread sizes (e.g. GL45, S38) | page 63
- + **Level sensors** to connect bottles directly to HPLC instruments and monitor / manage bottles in process-related steps automatically | page 46

Specially developed S40 thread
withstands higher contact pressure
and ensures tighter seals

**Specially formed,
sharp thread lip**
for safe drip free pouring

**Specially treated
high quality glass**
with extreme durability due to
constant wall thickness for highest
safety and product quality

**Pour ring for safe and
ergonomic withdraw**
tension-free
manufacturing technology:
"bottle out of one drop" to
avoid any predetermined
breaking point

New S40 screw cap
Tamper proof closure will remain
as ring on the bottle neck

Long shelf life of contents
due to bottle's impermeability
to air and water vapor as well
as protection against light

**Unique, clear and
complete labeling**
with product specifications
and all relevant hazard
declarations

Broad and stable base
for safe stand with low point
of gravity



Technical data

Material:

Moulded amber glass, hydrolytic class 3

Available packaging size:

0.5 L, 1 L, 2.5 L and 4 L

Height, diameter and net weight (bottle size):













180 mm, ø 83 mm, approx. 450 g (0.5 L)

222 mm, ø 101 mm, approx. 600 g (1 L)

258 mm, ø 151 mm, approx. 1,140 g (2.5 L)

350 mm, ø 162 mm, approx. 1,525 g (4 L)

Safety accessories for Amber Glass Bottles | pages 20-23

Products	Ord. No.
Safe handling	
 Safety carrier for 1L / 2.5l glass bottles	9.20078.0001
 Safety carrier for 4L glass bottles	1.40140.0001
 Pouring aid for 1L / 2.5 glass bottles	1.02547.0005
 Bottle opening key S40 / S28	1.08801.0001
 Label set for self-labelling mixtures	1.00801.0001
Withdrawal systems for solvents in glass bottles	
 Withdrawal system for bottles with manual pressure build-up	1.78178.0001
Adapters for direct connection of solvent bottles to HPLC-instruments	
 HPLC-bottle adapter S40 (supply)	1.03830.0001
 HPLC-bottle adapter S40 (disposal)	1.03831.0001
 Exhaust air filter for HPLC-bottle adapter S40 (disposal)	1.03833.0001
Adapters for direct connection of solvent bottles to HPLC-instruments WITH LEVEL SENSOR technology	
 Adapter with integrated level sensor (supply)	9.67100.2001
 Adapter with integrated level sensor (disposal)	9.67100.2002
 Display and alarm device for bottle level sensor	9.67100.2004

HDPE bottles

[available from 1 L up to 5 L]



- + **Withdrawal system** for bottles | pages 22-23
- + **Adapter** to connect equipment with different thread sizes (e.g. GL45, S38) | page 63

Specially developed S40 thread withstands higher contact pressure and ensures tighter seal

Specially formed sharp thread lip for safe drip free pouring

Specially treated high quality HDPE with extreme durability, inertness and shock resistance for highest safety and product quality

Reduced packaging waste (no additional protection material necessary inside cardboard boxes) to protect the environment and to benefit from economical advantages



New S40 screw cap
Tamper proof closure will remain as ring on the bottle neck

Integrated handle for best pouring properties

Unique, clear and complete labeling with product specifications and all relevant hazard declarations

Low bottle weight for easy, safe and economic solvent handling

Special base geometry of 2.5L bottles prevents bulging

Technical data

Material:

HDPE (High-density polyethylene)

Available packaging size:

1 L, 2.5 L and 5 L

Height, diameter and net weight (bottle size):





206 mm, \varnothing 101 mm, approx. 66 g (1 L)

322 mm, \varnothing 125 mm, approx. 145 g (2.5 L)

330 mm, \varnothing 178 mm, approx. 335 g (5 L)



Safety accessories for HDPE Bottles | pages 20-23

Products	Ord. No.
Safe handling	
 Bottle opening key S40 / S28	1.08801.0001
 Label set for self-labelling mixtures acc. to GHS, DIN EN ISO & GLP	1.00801.0001
 Safety stand for 2.5L HDPE bottles	9.67213.0001
Withdrawal systems for solvents in HDPE bottles	
 Withdrawal system for bottles with manual pressure build-up	1.78178.0001

Aluminum bottle

[available for 5 L]



- + **Withdrawal system** for bottles | pages 22-23
- + **Adapter** to connect equipment with different thread sizes (e.g. GL45, S38) | page 63



Technical data









Material: Aluminum

Available packaging size: 5 L

Height, diameter and net weight:

298 mm, \varnothing 175 mm, approx. 285 g

Safety accessories for Aluminum Bottles | pages 20-23

Products	Ord. No.
Safe handling	
 Bottle opening key S40 / S28	1.08801.0001
 Label set for self-labelling mixtures acc. to GHS, DIN EN ISO & GLP	1.00801.0001
Withdrawal systems for solvents in aluminum bottles	
 Withdrawal system for bottles with manual pressure build-up	1.78178.0001
Adapters for direct connection of solvent bottles to HPLC-instruments	
 HPLC-bottle adapter S40 (supply)	1.03830.0001
 HPLC-bottle adapter S40 (disposal)	1.03831.0001
 Exhaust air filter for HPLC-bottle adapter S40 (disposal)	1.03833.0001
Adapters for direct connection of solvent bottles to HPLC-instruments WITH LEVEL SENSOR technology	
 Adapter with integrated level sensor (supply)	9.67100.2001
 Adapter with integrated level sensor (disposal)	9.67100.2002
 Display and alarm device for bottle level sensor	9.67100.2004

Safety accessories for bottles

Handling hazardous goods daily demands highest health protection. Specially for solvents in glass bottles there are several additional safety products available that increase your laboratory safety dramatically.



Safety carrier

for glass bottles up to 2.5 L [9.20078.0001]
and up to 4 L [1.40140.0001]

- Safe transportation of glass bottles acc. to guidelines
- Optimal bottle protection due to very effective PE foam inlay
- Additional time for disposal in case of glass breakage inside due to chemical resistant materials
- Leak-proof top cover prevents unintended exposure to liquids and vapors
- Stable, broad handle for convenient handling

Bottle key

[1.08801.0001]

- Convenient opening and closing of bottles with S40 and S28 screw caps
- Perfectly adapted to the shape of our screw caps
- Maximum safety when working with hazardous liquids



Safety stand

for 2.5L-HDPE-bottles [9.67213.0001]

- Additional safety e.g. when using the withdrawal system 1.78178.0001 with 2.5 L HDPE bottles
- Prevents overturning of the 2.5 L HDPE bottle

Pouring aid

for 1L and 2.5L Merck bottles with S40 thread (pack of 5) [1.02547.0005]

- Easy, safe and convenient pouring for S40-threaded bottles without integrated handle
- Suitable for all liquids like acids, bases and solvents
- Clipped directly on the bottle neck
- Only for single use – do be disposed of with the bottle: Maximum safety – avoid potential risk of breakage! (Some liquids have a decomposing effect on the pouring aid material.)



Label set

acc. to GHS, DIN EN ISO and GLP [1.00801.0001]

- Comprehensive label compliant with GHS, DIN EN ISO and GLP standards
- Complete safety information at a glance with adhesive pictograms and signal words
- Non-permanent adhesive for easy, residue-free removal
- Robust plastic label, resistant to chemicals



HPLC adapter

for direct instrument connection [1.03830.0001 (supply) and 1.03831.0001 + 1.03833.0001 (disposal)]

- Direct instrument adapter for S40-threaded bottles
- No harmful evaporations
- Contamination-free solvent handling
- Stable eluent mixture ratio without contamination
- Easy exchange of bottles
- Multiple connection possibilities



Adapter with integrated level sensor

for Merck bottles with S40 thread for solvent supply [9.67100.2001] and for solvent disposal [9.67100.2002]

- Suitable for solvents (!) in all S40 bottles
- The level sensor is pre-assembled in an S40 screw cap with additional 3 openings for 3 mm HPLC-tubes and blind plugs
- Equipped with a clamping screw, the sensor can be adjusted to several bottle sizes or also to the desired solvent level.
- Optical and acoustic signals in connection to an alarm display. [9.67100.2004]



Safety accessories for bottles

Withdrawal system with manual pressure build-up for solvents in bottles

Suitability: All Merck-bottles up to 5 L volume



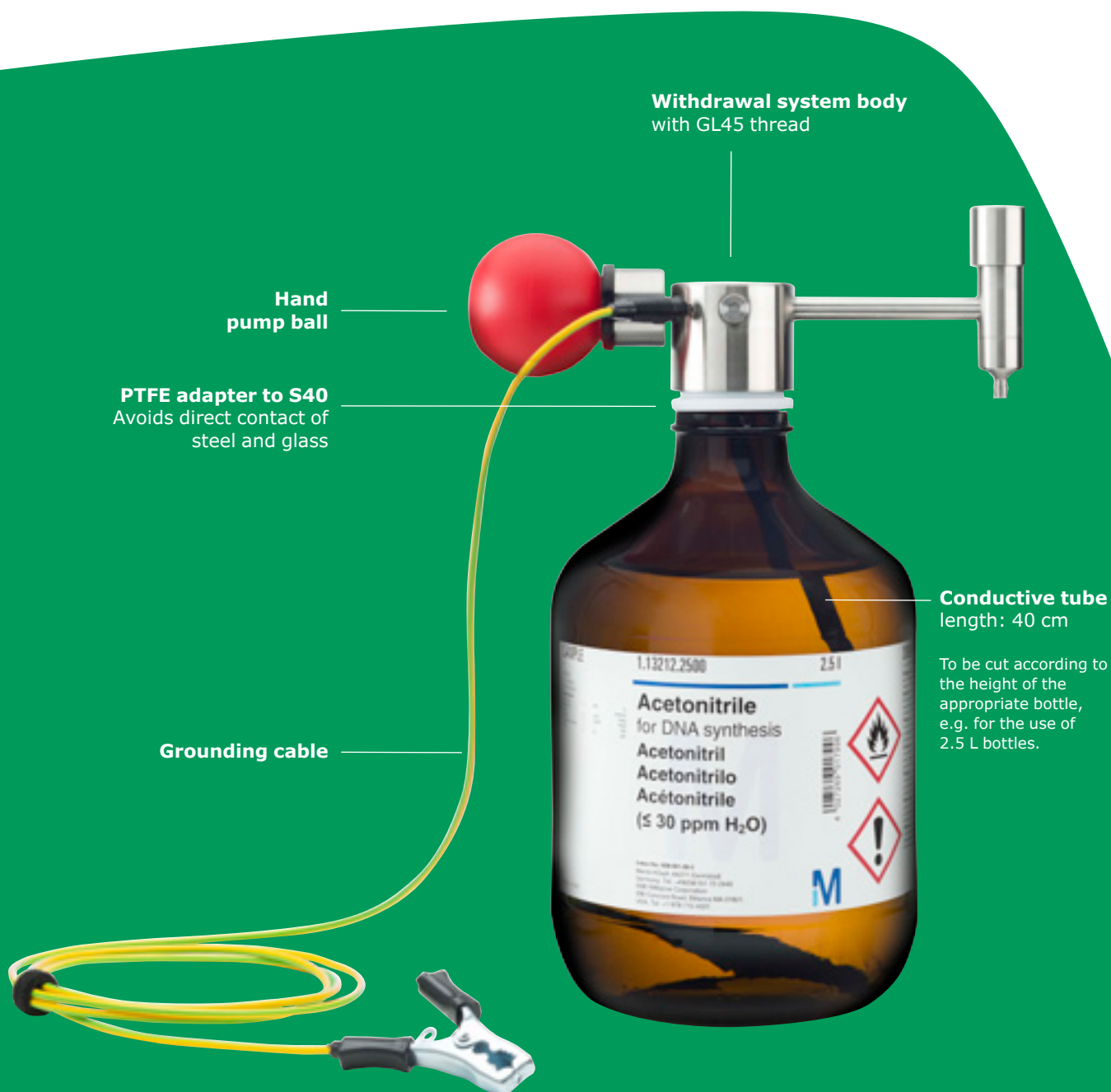

Operation mode: Manual pressure build-up by hand pump ball



Your benefits

- **Safe, easy and contamination-free** solvents withdrawal out of S40 threaded bottles
- **Safety** - safe bottle position and convenient withdrawal of solvents by avoiding pouring
- **Flexibility** - suitable for all Merck-bottles made of glass, HDPE and aluminum up to 5 liters

Accessories | pages 20-22

Products	Ord. No.
Safe handling	
 Safety carrier for 1L / 2.5 L glass bottles	9.20078.0001
 Safety carrier for 4L glass bottles	1.40140.0001
 Bottle opening key S40 / S28	1.08801.0001
 Label set for self-labelling mixtures	1.00801.0001
Spare parts	
 Conductive tubing (5 units, length: 40 cm)	1.78179.0001

Drums at a glance

As the global market leader in laboratory reagents, we apply our demanding quality and safety standards not only to our reagents themselves, but also to the containers we supply them in. That's why we continuously develop and improve packaging and tailor-made solvent withdrawal systems that meet the requirements of our customers. Today we are able to provide a broad range of withdrawal systems and containers that is unrivaled by any other manufacturer.

Solvent management solutions from Merck help to improve your materials management, to minimize the environmental impact of packaging waste and health risks for your employees, and to implement more cost-effective disposal processes.



Your benefits

- Maximum user safety
- Easy and contamination-free solvent handling
- Application orientated solutions and individual installations
- Ecological and economical benefits

RETURNABLE
PACKAGING 

10 L



25 L



190 L

**Stainless steel drums | page 26**

- Optimum material characteristics (avoidance of interactions between solvents and packaging material)
- Use as returnable drums
- Can be combined with a variety of withdrawal systems and level sensors
- Optimum emptying
- Stackable

Withdrawal systems

Take advantage of perfectly matched systems for maximum safety in your individual application.

- ▶ Manual withdrawal system | page 28
- ▶ Withdrawal system with inert gas pressurizing | page 29
- ▶ Direct instrument connections | page 31

ONE-WAY
PACKAGING

10 L



25 L



180 / 190 L

**Metal drums | page 32**

In addition to conventional packaging we also implement specific solutions especially for production use. This range includes steel drums from 10 to 180 / 190 liters, depending on the solvent, with a PE-inliner.

Withdrawal systems

Take advantage of perfectly matched systems for maximum safety in your individual application.

- ▶ Manual withdrawal system | pages 30 & 35



Stainless steel returnable drums

[available from 10 L up to 190 L]



- + **Withdrawal system** for manual pressure build-up | pages 28 & 30
- + **Withdrawal system** for pressurizing with inert gas | page 29



Technical data

Parameter	10 L	25 L	190 L
Height	35 cm	52 cm	88 cm
Diameter	24 cm	29 cm	59.5 cm
Volume	13 L	28 L	215 L
Filling quantity	10 L	25 L	190 L
Weight (empty)	1.9 kg	3.8 kg	18 kg
Number per pallet	15	11	2
Openings	2" centrally and 3/4" decentrally located		
Material	stainless steel 1.4301		

Safety accessories for Stainless Steel Drums | pages 48-51

Products	Ord. No.
Safe handling	
 Bottle opening key S40 / S28	1.08801.0001
 Label set for self-labelling mixtures	1.00801.0001
 Antistatic set (3 cables)	1.07070.0001
 Stainless steel clamp for filling nozzle, wall attachment	9.67107.0001
 Stainless steel clamp for filling nozzle, attachment to drums	9.67106.0001
 Reducing valve, 0.2 bar with integrated overpressure relief	9.67100.9100
 Pressure safety device, 0.5 bar	9.67100.9004
Withdrawal systems for solvents in drums	
 Withdrawal system with manual pressure build-up	1.01114.0001
 Withdrawal system for inert gas pressurizing	1.06710.0001 (additional dip tube necessary)
Dip tubes for inert gas withdrawal system 1.06710.0001	
 Dip tube for 10 l stainless steel drums	9.67100.1010
 Dip tube for 25 l stainless steel drums	9.67100.1025
 Dip tube for 190 l stainless steel drums	9.67100.1190

Withdrawal systems for stainless steel returnable drums



Manual pressure build-up by pump ball

- Tested high performance materials to avoid any contamination caused by the system components
- Safe, easy and convenient solvent handling
- High flexibility due to no dependence on gas supply
- Cost effective solution due to economic concept of returnable containers

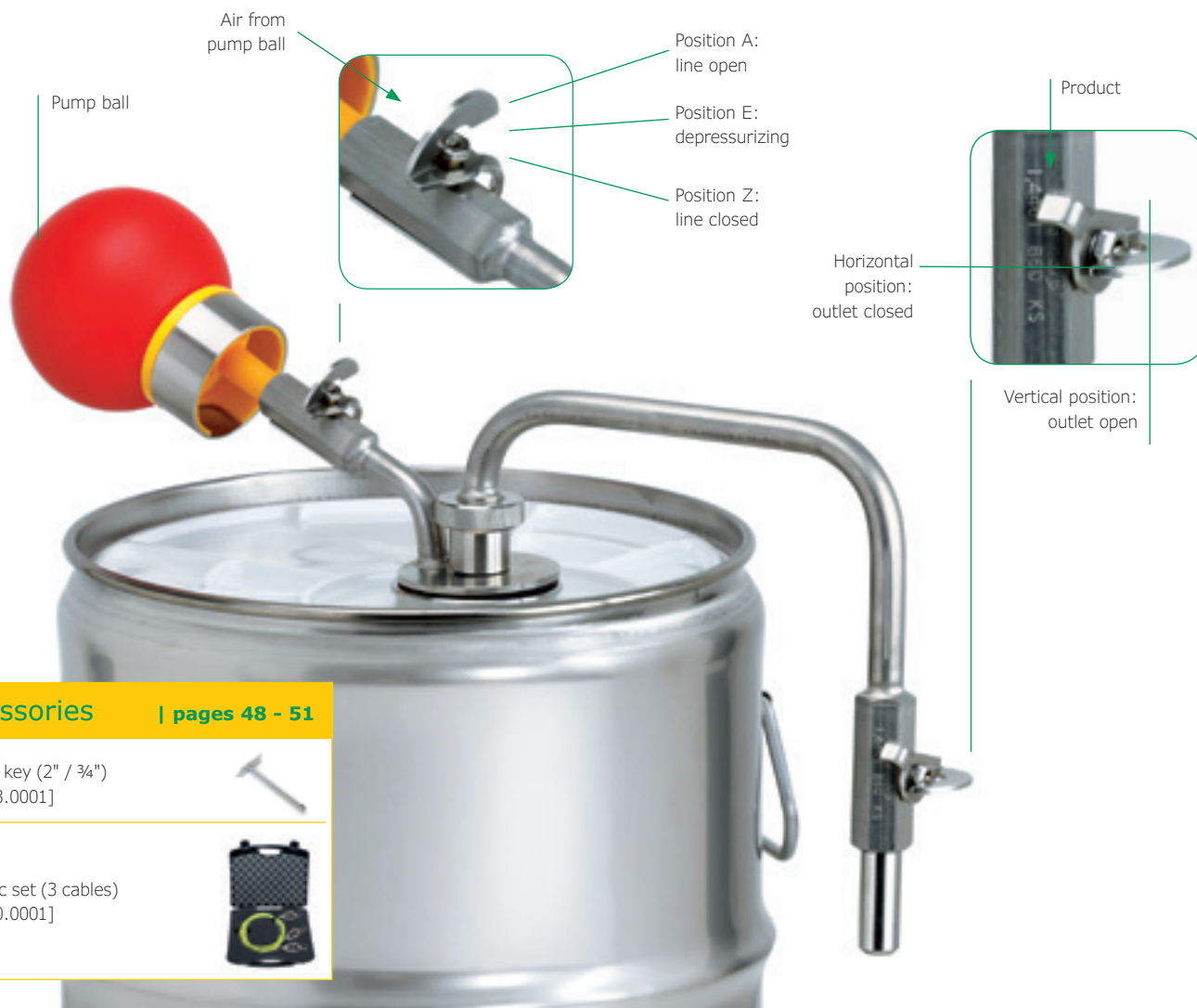

Accessories | pages 48 - 51

Opening key (2" / ¾")
[1.08803.0001]



Antistatic set (3 cables)
[1.07070.0001]



Spare parts

Dip tube for 10 L drums
[9.67100.1012]



Dip tube for 25 L drums
[9.67100.1028]



Hand pump ball
[9.67114.0000]



System at a glance

Order number	1.01114.0001
Suitability	10 L and 25 L metal and stainless steel drums
Operation mode	Manual pressure build-up by pump ball
Set components	Withdrawal system body with 2" clamp, 2 shut-off valves (discharge and ventilation), exhaust function hand pump ball with rapid-action connector, 10 L dip tube, 25 L dip tube



Pressurizing with inert gas

- Tested high performance materials to avoid any contamination caused by the system components
- All materials made of stainless steel and special sealing material with no organic compounds detectable
- Safe, easy and convenient solvent handling
- No risk of contamination from incoming air
- Cost effective solution due to economic concept of returnable container handling
- Permits construction of a central supply system
- Flexible product feed



Two different **connectors** for avoiding mismatch of gas and product

Stainless steel clamp

to attach nozzle directly and drip-free to the drum [9.67106.0001]

Safety hook to avoid unintended solvent supply (push safety hook first to unblock the supply handle)

Filling nozzle with stainless steel coated PTFE tube [9.67100.9090]

Integrated swivel joint to avoid tube tensions

Self-closing tear-off connectors for quick connection and disconnection

Spiral gas feeding tube [9.67100.9051]

Necessary complete products | pages 60 - 61

Dip tube for 10 L stainless steel drums [9.67100.1010]



Dip tube for 25 L stainless steel drums [9.67100.1025]



Dip tube for 190 L stainless steel drums [9.67100.1190]



Accessories | pages 48 - 51

Opening key (2" / 3/4") [1.08803.0001]



Antistatic set (3 cables) [1.07070.0001]



Reducing valve, 0.2 bar [9.67100.9100]



Pressure safety device, 0.5 bar [9.67100.9004]



Stainless steel clamp for filling nozzle, wall attachment [9.67107.0001]



Stainless steel clamp for filling nozzle attachment to drums [9.67106.0001]



System at a glance

Order number	1.06710.0001
Suitability	10 L, 25 L and 190 L stainless steel drums 10 L, 30 L and 185 L stainless steel barrels
Operation mode	Pressurizing with inert gas (house gas / gas bottle)

Set components Filling nozzle with stainless steel coated, flexible PTFE tube, 80 cm [9.67100.9090], Gas feeding tube [9.67100.9051], threaded adapter with vertical connections [9.67100.9002]. Please complete the set by adding the appropriate dip tube for your solvents container.

Spare parts [as shown in the picture]

Filling nozzle with stainless steel coated, flexible PTFE tube (80 cm) [9.67100.9090]

Gas feeding tube [9.67100.9051]

Threaded adapter with horizontal connections [9.67100.9003]

Threaded adapter with vertical connections [9.67100.9002]

Withdrawal systems and direct connections for stainless steel returnable drums



Manual pressure build-up for high volumes by foot pump ball

- Safe, easy and convenient solvent handling
- Tested high performance materials to avoid any contamination caused by the system components
- High flexibility due to independence on gas supply



Accessories

| pages 48-49

Opening key (2" / 3/4")
[1.08803.0001]



Antistatic set (3 cables)
[1.07070.0001]



System at a glance

Order number	1.19171.0001
Suitability	180 L / 190 L / 200 L metal, stainless steel and composite drums (steel/PE)
Operation mode	Manual pressure build-up by foot pump ball
Set components	Withdrawal system body with 2" thread, foot pump ball with flexible tube and rapid-action connector, adjustable dip tube



Direct connections to various instruments or product lines

Stainless steel drum with direct instrument connection

Customer's tubing

e.g. lines to instruments

Options to choose / alternatives

(Please choose either a tube or a nipple to connect existing lines.)

Stainless steel coated PTFE tube, 80 cm with nipple and (options)

- quick connector Rectus Type 21, female [9.67100.9058]
- threaded connector G3/8 (inner thread) [9.67100.9052]
- pipe connector for 10 mm tubes [9.67100.9057]

Nipple with tube connector, without tube (options)

- for flexible hoses of 3 x 1.5 mm [9.67100.1076]
- for flexible hoses of 6 x 4 mm [9.67100.1064]
- for flexible hoses of 8 x 6 mm [9.67100.1061]

Dip tube (options)

- 10 L stainless steel drum [9.67100.1010]
- 25 L stainless steel drum [9.67100.1025]
- 190 L stainless steel drum [9.67100.1190]

Reducing valve with integrated overpressure relief (IN / OUT: tube connector for hoses with 6 mm inner diameter) [9.67100.9100]

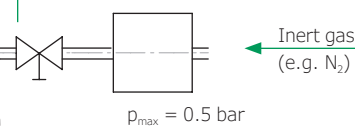

Gas feeding tube

[9.67100.9051]

Threaded adapter (options)

- with vertical connectors [9.67100.9002]
- with horizontal connectors [9.67100.9003]

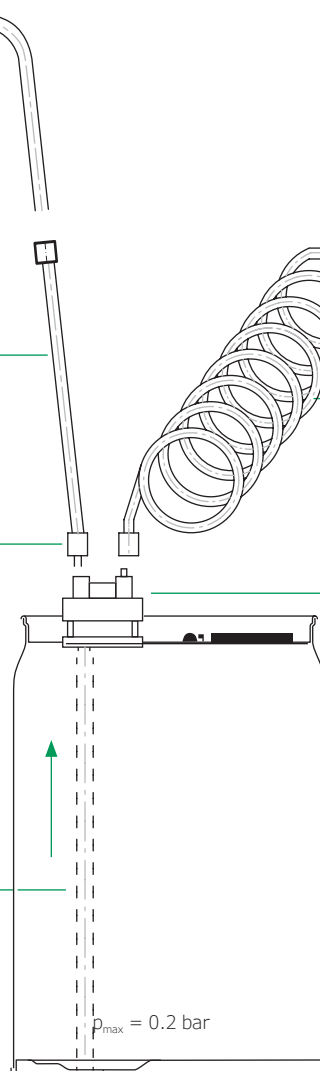
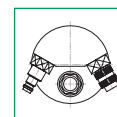

Direct connections to instruments or product lines are a safe option to increase process effectiveness. Customized installations are available on request with individual compilations of necessary products and technical drawings.

Please contact your Merck supplier to discuss your individual requirements.

Accessories | pages 48-51

One-way metal drums

[available from 10 L up to 180 L]









+ **Withdrawal system** for manual pressure build-up | pages 34-35



Technical data

Parameter	10 L	25 L	25 L with PE	180 L	180 L with PE
Height	34 cm	52 cm	52 cm	88 cm	88.5 cm
Diameter	24.5 cm	29 cm	29 cm	59.5 cm	60 cm
Volume	13.5 L	28 L	28 L	216.5 L	203 L
Filling quantity	10 L	25 L	25 L	180 L	180 L
Weight (empty)	1.8 kg	3.6 kg	3.4 kg	21.3 kg	21.5 kg
Number per pallet	13	11	11	2	2
Openings [located]	2" [decentr.]	2" [centr.] and 3/4" [decentr.]	S56 x 4 (PP)	2" [centr.] and 3/4" [decentr.] (steel, galvanized)	2" with 3/4" (PP)
Material	steel	steel	steel with PE	steel	steel with PE

Safety accessories for One-way Metal Drums | pages 48-49

Products	Ord. No.
Safe handling	
 Opening key (2" /3/4")	1.08803.0001
 Label set for self-labelling mixtures	1.00801.0001
 Antistatic set (3 cables)	1.07070.0001
Withdrawal systems for solvents in drums	
 Withdrawal system with manual pressure build-up	1.01114.0001
 Withdrawal system with manual pressure build-up (foot pump ball)	1.19171.0001
Dip tubes for inert gas withdrawal system 1.06710.0001	
 Dip tube for 25 L composite drums (steel/PE) for system 1.01114.0001	9.67100.1026



Withdrawal systems for one-way metal drums

- Safe, easy and convenient solvent handling
- Tested high performance materials to avoid any contamination caused by the system components
- High flexibility due to independency on gas supply

Manual pressure build-up by pump ball



Accessories

| pages 48-49

Opening key (2" / 3/4")
[1.08803.0001]



Antistatic set (3 cables)
[1.07070.0001]



Dip tube for 25 L composite drum
(steel/PE) [9.67100.1026]



Spare parts

Dip tube for 10 L drums
[9.67100.1012]



Dip tube for 25 L drums
[9.67100.1028]



Hand pump ball
[9.67114.0000]



System at a glance

Order number

1.01114.0001

Suitability

10 L and 25 L metal, stainless steel and composite drums (steel/PE)

Operation mode

Manual pressure build-up by pump ball

Set components

Withdrawal system body with 2" clamp, hand pump ball with rapid-action connector, 10 L dip tube, 25 L dip tube. Please order the dip tube 9.67100.1026 for the usage with 25l composite drums (steel/PE).

Manual pressure build-up for high volumes by foot pump ball



Accessories

| pages 48-49

Opening key (2" / 3/4")
[1.08803.0001]



Antistatic set (3 cables)
[1.07070.0001]



Reducer (PE) from S56 x 4 to 2" thread (2" coarse to 2" fine thread)
[9.67202.0000]



System at a glance

Order number 1.19171.0001

Suitability 180 L / 190 L / 200 L metal, stainless steel and composite drums (steel/PE)

Operation mode Manual pressure build-up by foot pump ball

Set components Withdrawal system body with 2" thread, foot pump ball with flexible tube and rapid-action connector, adjustable dip tube

Barrels – high quality return system

As the global market leader in laboratory reagents, we apply our demanding quality and safety standards not only to our reagents themselves, but also to the containers we supply them in. That's why we continuously develop and improve packaging and tailor-made solvent withdrawal systems that meet the requirements of our customers. Today we are able to provide a broad range of withdrawal systems and containers that is unrivaled by any other manufacturer.

Solvent management solutions from Merck help to improve your materials management, to minimize the environmental impact of packaging waste and health risks for your employees, and to implement more cost-effective disposal processes.



Your benefits

- Maximum user safety
- Easy and contamination-free solvent handling
- Application orientated solutions and individual installations
- Ecological and economical benefits



10 L



30 L



185 L



Stainless steel barrels | pages 38-39

Withdrawal systems

Stainless steel, due to its properties (e.g. its inertness), is an ideal packaging material, particularly with regard to the maintenance of the quality of solvents. Merck has thus been using stainless steel barrels for various types of highly purified solvents for many years. The range of stainless steel barrels currently comprises 10 liter, 30 liter and 185 liter volumes.

Take advantage of perfectly matched systems for maximum safety in your individual application.

- Optimum material characteristics (avoidance of interactions between solvents and packaging material)
- Use as returnable barrels
- Can be combined with a variety of withdrawal systems and level sensors
- Optimum emptying
- Stackable

- ▶ Manual withdrawal system | page 40
- ▶ Withdrawal system with inert gas pressurizing | page 41
- ▶ Direct instrument connections | pages 42-43

Cabinet storage and other varieties | pages 42-45

Direct connections to instruments or product lines serve as safe option to increase process effectiveness.

Customized installations are available on request with individual compilations of necessary products and technical drawings. Please contact your Merck supplier to discuss your individual requirements.



10 L



30 L

Fully sealed stainless steel barrels | page 33

Withdrawal systems

For maximum dryness, we provide our dried solvents in specially designed stainless steel barrels with integrated dip tube. By using the appropriate withdrawal system, it is possible to prevent the solvent from contamination with moisture from the atmosphere. These specially tailored systems safeguard solvent quality and keep your analyses safe and dependable.

Take advantage of perfectly matched systems for maximum safety in your individual application.

- ▶ Withdrawal system with inert gas pressurizing | page 41
- ▶ Direct connections | pages 42-43

Stainless steel barrels

[available from 10 L up to 185 L]



- + **Withdrawal system** manual pressure build-up | page 38
- + **Withdrawal system** for pressurizing with inert gas | page 41
- + **Direct connection** to instruments | page 43
- + **Level sensors** | pages 50-51

Safe and easy handling
due to two large handles
(optimal position for
grounding clamps)

Standard openings
to ensure highest
interoperability

Specially formed rims for best
stackability

Protective cap
with originality sealing

Engraved UN code
includes important safety
information and provides
packaging certification

**High quality
stainless steel**
with extreme
durability, inertness
and shock resistance
for highest safety and
product quality

**Unique, clear and
complete labeling** with
product specifications
and all relevant hazard
declarations

RETURNABLE
PACKAGING

**Cost
effectiveness and
environmental
protection** by using
the barrel returning
process



Bottom reservoir
for optimal emptying









Technical data

Parameter	10 L barrel	30 L barrel	185 L barrel
Height	31 cm	44 cm	97 cm
Diameter	28 cm	37 cm	58 cm
Wall thickness	1.5 mm	1.5 mm	1.5 mm
Volume	12 L	33.5 L	206 L
Filling quantity	10 L	30 L	185 L
Weight (empty)	5.5 kg	9.6 kg	31 kg
Number per pallet	11	6	2
Openings	2" centrally and 3/4" decentrally located		
Material	stainless steel 1.4301		





Safety accessories for Stainless Steel Barrels | pages 48 - 49

Products	Ord. No.
----------	----------

Safe handling



	Opening key (2" /3/4")	1.08803.0001
	Label set for labelling own containers acc. to GHS, DIN EN ISO, GLP	1.00801.0001
	Antistatic set (3 cables)	1.07070.0001
	Stainless steel clamp for filling nozzle, wall attachment	9.67107.0001
	Stainless steel clamp for filling nozzle, attachment to drums	9.67106.0001
	Reducing valve, 0.2 bar with integrated overpressure relief	9.67100.9100
	Pressure safety device, 0.5 bar	9.67100.9004

Withdrawal systems for solvents in drums



	Withdrawal system with manual pressure build-up	1.01123.0001
	Withdrawal system for inert gas pressurizing	1.06710.0001 (additional dip tube necessary)
	Dip tube for 10 l stainless steel barrels (for 1.06710.0001)	9.67100.1040
	Dip tube for 30 l stainless steel barrels (for 1.06710.0001)	9.67100.1041
	Dip tube for 185 l stainless steel barrels (for 1.06710.0001)	9.67100.1185

Products	Ord. No.
----------	----------

Direct instrument connections

	HPLC bottle adapter S40 (supply) with valve and filter for direct bottle connection to HPLC tubes	1.03830.0001
	Reducer (stainless steel) from 2" to S40 thread	1.01111.0001

Level sensors with continuous level detection

	Level sensor for 10 l stainless steel barrels	1.67710.0001
	Level sensor for 30 l stainless steel barrels	1.67730.0001
	Level sensor for 185 l stainless steel barrels	1.67785.0001

Fully sealed stainless steel barrels

Material: Stainless steel

Available packaging size: 10 L and 30 L barrels

Dimensions and net weight (barrel size):

31 cm, ø 28 cm, 5.5 kg (10 L)

44 cm, ø 37 cm, 9.6 kg (30 L)

Safety: Fully sealed system

Specifics: Maximum protection against water contamination of dried solvents



Withdrawal systems for stainless steel returnable barrels



Manual pressure build-up

- Safe, easy and convenient solvent handling
- Tested high performance materials to avoid any contamination caused by the system components
- High flexibility due to independence on gas supply



Accessories | pages 48 – 49

Opening key (2" / 3/4")
[1.08803.0001]



Antistatic set (3 cables)
[1.07070.0001]



Spare parts

Dip tube for 10 L barrels
[9.67100.1011]



Dip tube for 30 L barrels
[9.67100.1029]



Hand pump ball
[9.67114.0000]



Hand pump ball with quick connector [9.67100.1079]



System at a glance

Order number 1.01123.0001

Suitability 10 L and 30 L stainless steel barrels

Operation mode Manual pressure build-up by pump ball

Set components Withdrawal system body with 2" clamp, hand pump ball with rapid-action connector, 10 L dip tube, 30 L dip tube. Please complete the set by adding the appropriate dip tube for your solvents container.



Pressurizing with inert gas

- Safe, easy and convenient solvent handling
- Tested high performance materials to avoid any contamination caused by the system components
- Cost effective solution due to economic concept of returnable container handling
- Construction of a central supply system, direct connection to instruments or individual installations as options



Two different **quick connectors** for avoiding mismatch of gas and product. Horizontal connections available to reduce system height to a minimum. [9.67100.9003]

Self-locking tear-off connectors for quick connection and disconnection

Safety hook to avoid unintended solvent supply (push safety hook first to unblock the supply handle)

Spiral gas feeding tube [9.67100.9051]

Filling nozzle with stainless steel coated PTFE tube [9.67100.9090]

Integrated swivel joint to avoid tube tensions

Necessary complete products

Dip tube for 10 L barrels
[9.67100.1040]



Dip tube for 30 L barrels
[9.67100.1041]



Dip tube for 185 L barrels
[9.67100.1185]



Accessories | pages 48 – 49

Opening key (2" / 3/4")
[1.08803.0001]



Antistatic set (3 cables)
[1.07070.0001]



Reducing valve, 0.2 bar
[9.67100.9100]



Pressure safety device, 0.5 bar
[9.67100.9004]



Stainless steel clamp for filling nozzle,
wall attachment [9.67107.0001]



Spare parts (as shown in picture)

Filling nozzle with stainless steel coated, flexible
PTFE tube (80 cm) [9.67100.9090]

Gas feeding tube [9.67100.9051]

Threaded adapter with horizontal connections
[9.67100.9003]

Threaded adapter with vertical connections
[9.67100.9002]

System at a glance

Order number	1.06710.0001
Suitability	10 L, 25 L and 190 L stainless steel drums 10 L, 30 L and 185 L stainless steel barrels
Operation mode	Pressurizing with inert gas (house gas / gas bottle)
Set components	Filling nozzle with stainless steel coated, flexible PTFE tube, 80 cm [9.67100.9090], gas feeding tube [9.67100.9051], threaded adapter with vertical connections [9.67100.9002]



Cabinet storage and direct connections

Safety cabinet storage

Fixed withdrawal system with flexible filling nozzle

Using special installations our customers reach maximum safety standards in solvent handling. One important option is to store solvent barrels inside a safety cabinet. A customized installation with stainless steel tubing directly from the safety cabinet to the fume hood avoids having any open solvent barrel in the laboratory during solvent withdrawal. A filling nozzle placed easily accessible inside the fume hood can be safely operated, while the solvent barrel itself is stored inside the safety cabinet. No hazardous solvent vapors enter the laboratory, thus ensuring maximum safety for users and environment. **Please ask us for your individual installation.**

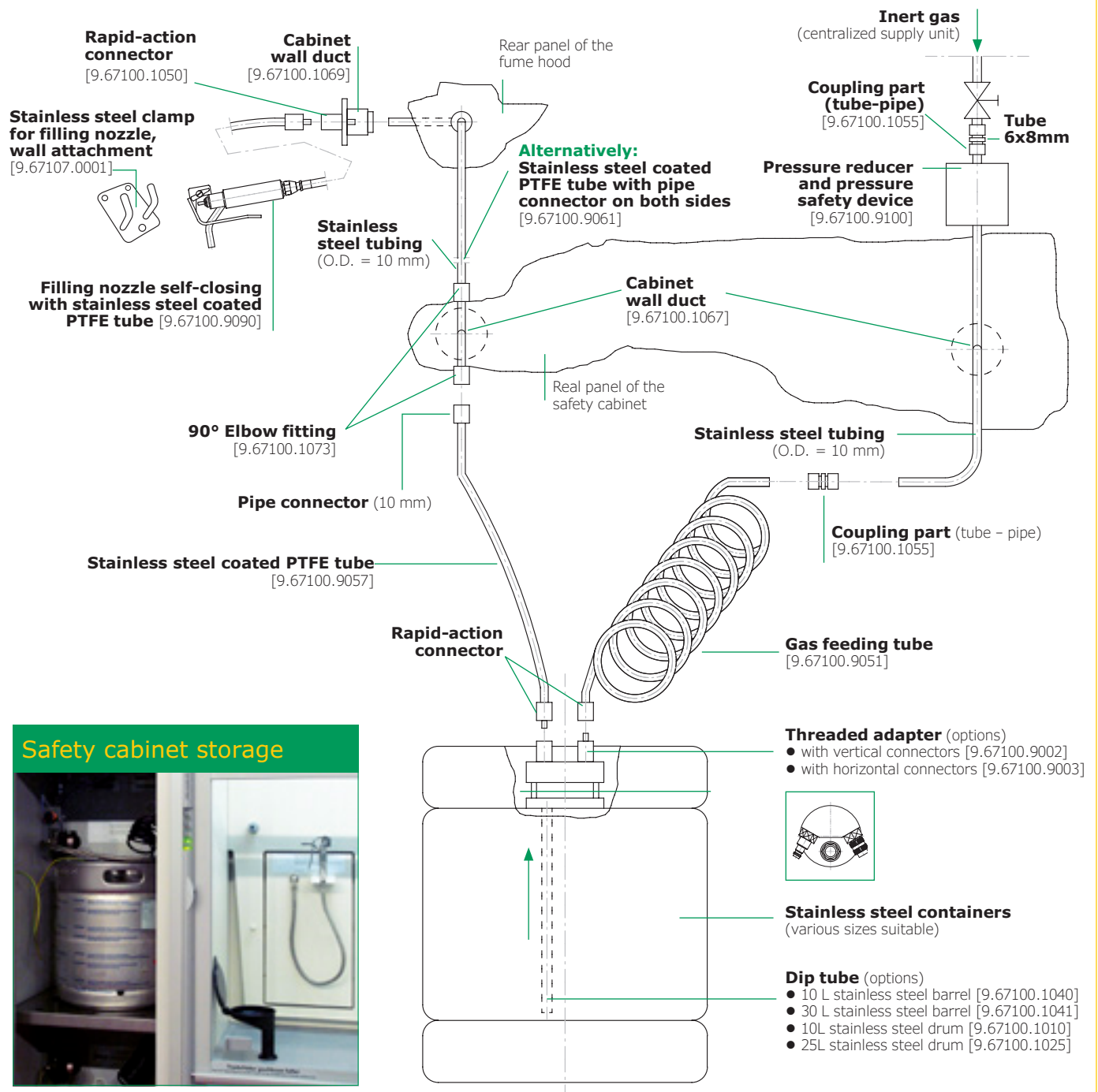

Safety cabinet storage



Direct connections to existing equipment

HPLC adapter for direct instrument connection



Direct connections of barrels to instruments can be easily done by using an adapter with the HPLC bottle adapter.

Benefits

- Maximum protection of users and environment by avoiding harmful emissions through integrated air vent / air filter
- Reliable analytical results and cost efficiency through contamination free solvent handling in a "closed system"
- Avoiding downtimes with firmly fixed capillaries, thus avoiding the air absorption
- Easy exchange of bottles due to free rotation (360°) of the HPLC adapter inlay

Stainless steel barrel with direct instrument connection

Customer's tubing
e.g. lines to instruments

Options to choose / alternatives

(Please choose either a tube or a nipple to connect existing lines.)

Stainless steel coated PTFE tube, 80 cm with nipple and (options)

- quick connector Rectus Type 21, female [9.67100.9058]
- threaded connector G3/8 (inner thread) [9.67100.9052]
- pipe connector for 10 mm tubes [9.67100.9057]

Nipple with tube connector, without tube (options)

- for flexible hoses of 3 x 1.5 mm [9.67100.1076]
- for flexible hoses of 6 x 4 mm [9.67100.1064]
- for flexible hoses of 8 x 6 mm [9.67100.1061]

Dip tube (options)

- 10 L stainless steel barrel [9.67100.1040]
- 30 L stainless steel barrel [9.67100.1041]
- 185 L stainless steel barrel [9.67100.1185]
- 10 L stainless steel drum [9.67100.1010]
- 25 L stainless steel drum [9.67100.1025]
- 190 L stainless steel drum [9.67100.1190]

Reducing valve with integrated overpressure relief (IN / OUT: tube connector for hoses with 6 mm inner diameter) [9.67100.9100]

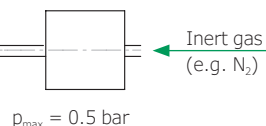

Gas feeding tube [9.67100.9051]

Threaded adapter (options)

- with vertical connectors [9.67100.9002]
- with horizontal connectors [9.67100.9003]

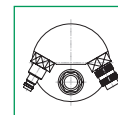

Another option is to connect solvent barrels directly from the safety cabinet to the HPLC instrument, thereby offering maximum user safety and environmental protection. Inert gas back-pressure can be applied to the barrel. Further process security can be provided by using the solvent level sensor technology. **These customized installations are available on request – please contact your Merck supplier to discuss your individual requirements.**



Central storage and supply

The various options in which individual components can be combined help you to optimize your work processes with regard to safety and efficiency. Where large volumes of solvents are turned around, delivery from a central safety cabinet or safety storage room to the point of use (e.g. laboratory fume hood) through a permanent supply circuit is one of the most rational ways of working.

Please talk to your local Merck supplier to find out your individual installation for your maximum safety.



Central supply from one safety cabinet to several laboratories / fume hoods.

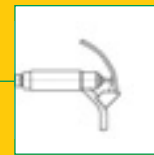

Laboratory 1



Laboratory 2

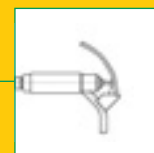

Laboratory 3



Special varieties

Merck's withdrawal systems cater to virtually any individual application. We provide an extensive range of withdrawal equipment and compatible accessories ranging from standard withdrawal systems for manual pressure build-up and systems that can be pressurized with inert gas, right up to customized solutions for individual installations. Especially for continuous solvent supply (e.g. 24/7 HPLC-run) a connection of several barrels in series could be a solution to reduce the complexity of your lab processes and save valuable time.

Connection in series

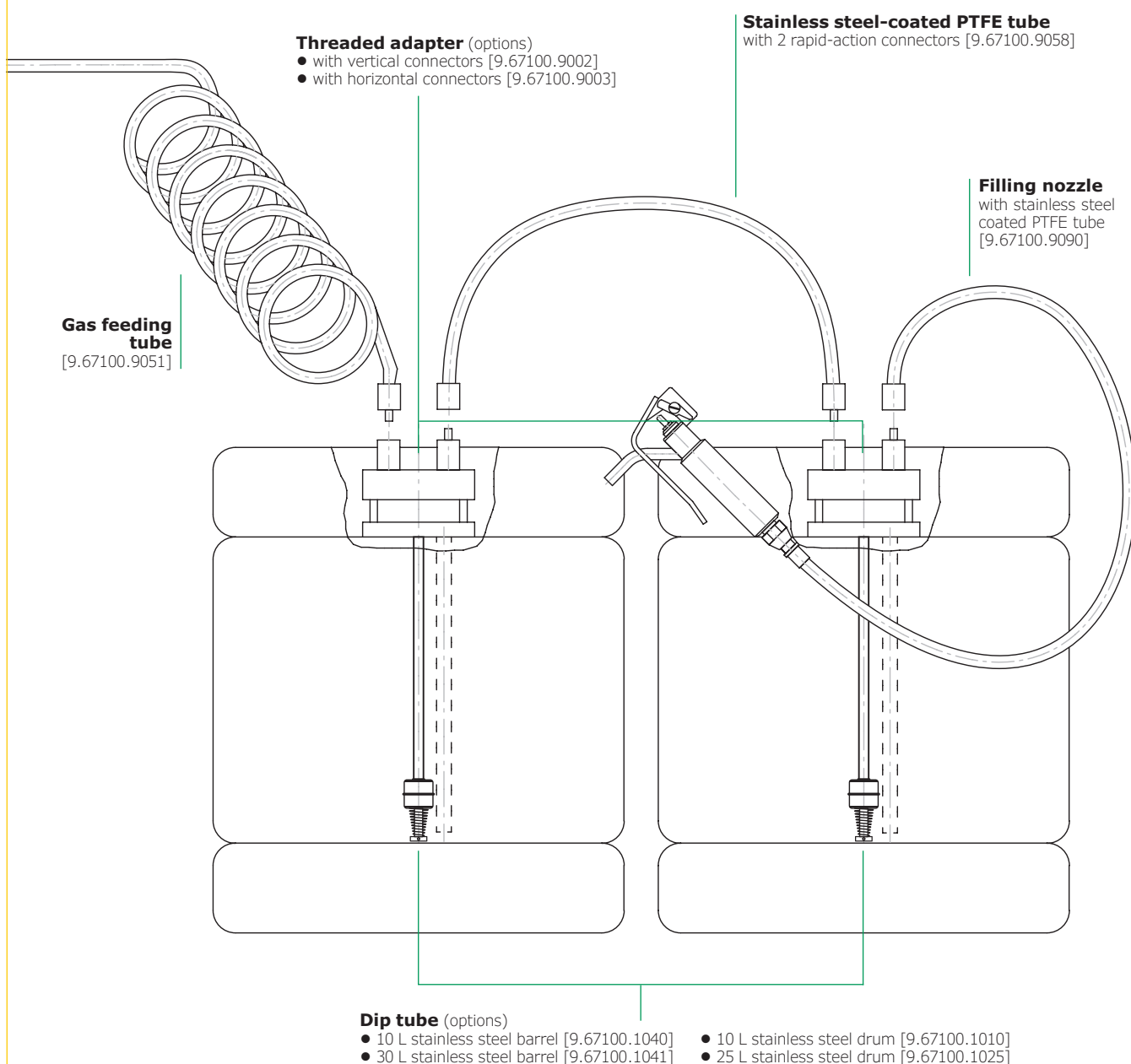

Containers for high volumes

[available from 400 L up to 1400 L]



- + **Direct connection** to existing equipment
- + **Sampling** unit for product coupling



Engraved UN code
includes important safety information and provides packaging certification

Standard openings and connections
to ensure highest interoperability

High quality stainless steel
with extreme durability, inertness and shock resistance for highest safety and product quality



Cost effectiveness and environmental protection by using the container returning process

Retraction shoes
for safe transportation





Bottom reservoir
for optimal emptying



Technical data

Material:	Stainless steel
Available packaging size:	400 L, 1,000 L and 1,400 L, or customized

Safety accessories for Containers | pages 48-51

Products	Ord. No.
Safe handling	
 Label set for self-labelling mixtures	1.00801.0001
 Antistatic set (3 cables)	1.07070.0001
Withdrawal components and adapters	
 Spiral gas feeding tube for coupling K	9.67100.9051
 Adapter for product connection (coupling M, SPM 08) to 1/2 NPT inner thread	9.67100.1086
Sampling unit for coupling M	9.67400.0001
Purging adapter for 9.67400.0001	9.67400.0002
Sampling unit for 1000 L container with Seliger coupling	1.67400.0001
Stainless steel coupling Seliger to G1" inner thread	1.67402.0001

Containers with volumes of 400 L and more are handled as customized packaging for standard and customized products.

Dedicated supply processes with rental agreements will be projected individually.

Please contact your local Merck supplier for further information and local availabilities.

Safety accessories for barrels & drums

Drum key

for opening and closing Merck barrels and drums with 2" and ¾" openings
[1.08803.0001]

The specially designed drum key ensures safe and easy handling of the locking device of Merck barrels and drums with 2" and ¾" opening.



Antistatic device

for grounding metal containers when dispensing and filling flammable solvents
[1.07070.0001]

If flammable liquids (e.g. solvents) are to be withdrawn or filled, the container must be properly grounded according to valid safety regulations to avoid explosions and fire risks. The relevant measures are to be taken to discharge static electricity. The antistatic device set allows quick and safe grounding of all components. It contains three cables for highest flexibility in grounding containers during all work steps. It comes in a suitcase for safe and professional storage of cables that are currently not in use. Cable length: 2 m

Reducing valve

with integrated excess pressure safety device [9.67100.9100]

The pressure reducer with included overpressure relief is one of the safest combined solutions for reducing inert gas house lines to a working pressure of 0.2 bar. The integrated overpressure relieve avoids pressures higher than 0.5 bar inside the barrel according the Pressure Equipment Directive. The pressure reducer is equipped with a ball valve and with two tube connectors 8 x 6 mm.



Pressure safety device 0.5 bar

[9.67100.9004]

The pressure safety device is used between the inert gas supply pressure bottle and the Merck barrel / drum to avoid pressures higher than 0.5 bar inside the barrel / drum according the Pressure Equipment Directive. It is equipped with two tube connections of 6 x 8 mm.

Safety wall ducts for safety cabinets and fume hoods

[9.67100.1067] and [9.67100.1069]

Individual solvent supply installations often include safety cabinets and fume hoods. The cabinet wall duct can be used as the link between the inner and outer side of safety cabinets with a maximum wall thickness of 55 mm. Connection ends are 10 mm tube ends. The hood wall duct can be used as link between the inner and outer side of the fume hood. It provides a 10 mm tube end on the outside and a G3/8 inner thread on the inner side.



9.67100.1067



9.67100.1069

Stainless steel clamp

for filling nozzle attachment to drums [9.67106.0001] or to walls [9.67107.0001]

Safety and convenient handling are the basis for an important part of very special Merck product developments. When using a pressurizing withdrawal system for stainless steel drums the Merck filling nozzle (9.67100.1090 / 9.67100.9090) can be placed safely even directly on the small rim of the drum by using our screw clamp. For individual solvent withdrawal installations that end with a flexible filling nozzle inside a fume hood, a clamp for wall fastening is now available.





Level sensors for process automation

Level sensors for bottles

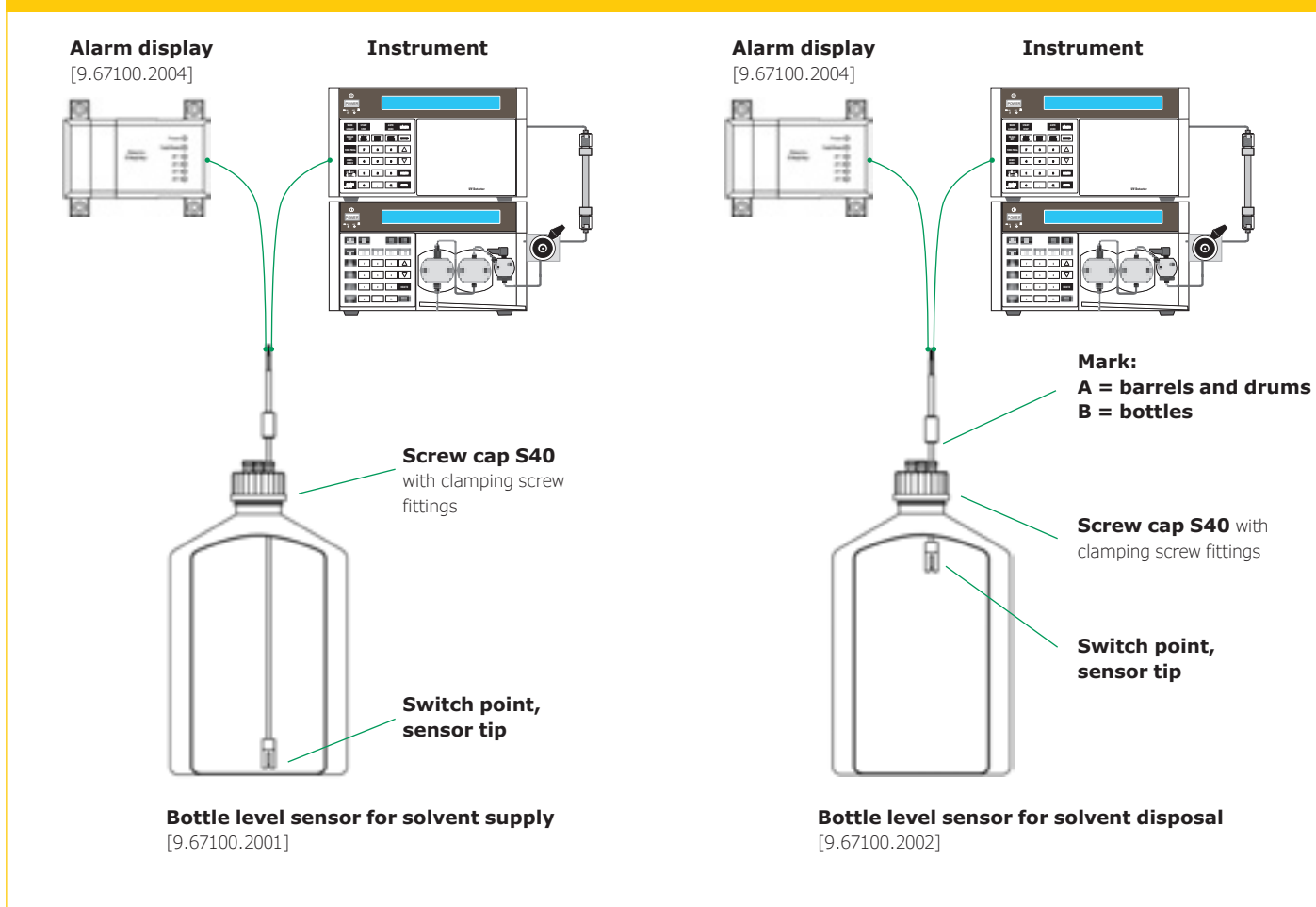

As the pioneer in lab scale level sensing Merck provides now a safe and convenient solution for process automation in laboratories. Primary for aluminum bottles but also for all other Merck solvent bottles with S40 thread the sensor is pre-assembled in a screw cap with three connection positions to connect e.g. HPLC tubes of 3 mm directly to the bottle. The S40 screw cap is screwed onto the top of the bottle. With a clamping screw the sensor can be adjusted to several bottle sizes or also to the desired level.

- **Connecting the sensor to an alarm display for optical and acoustic signalling** purposes at the workplace with a built-in acknowledgement function.
- **Connecting the bottle sensor signal directly to an HPLC instrument** allows automatical stopping of the HPLC run to ensure a consistent supply of mobile phase, thus avoiding any reconditioning of the column. For solvent disposal the sensor prevents from overfilling and from the occurrence of harmful situations.



Level sensors for barrels and drums

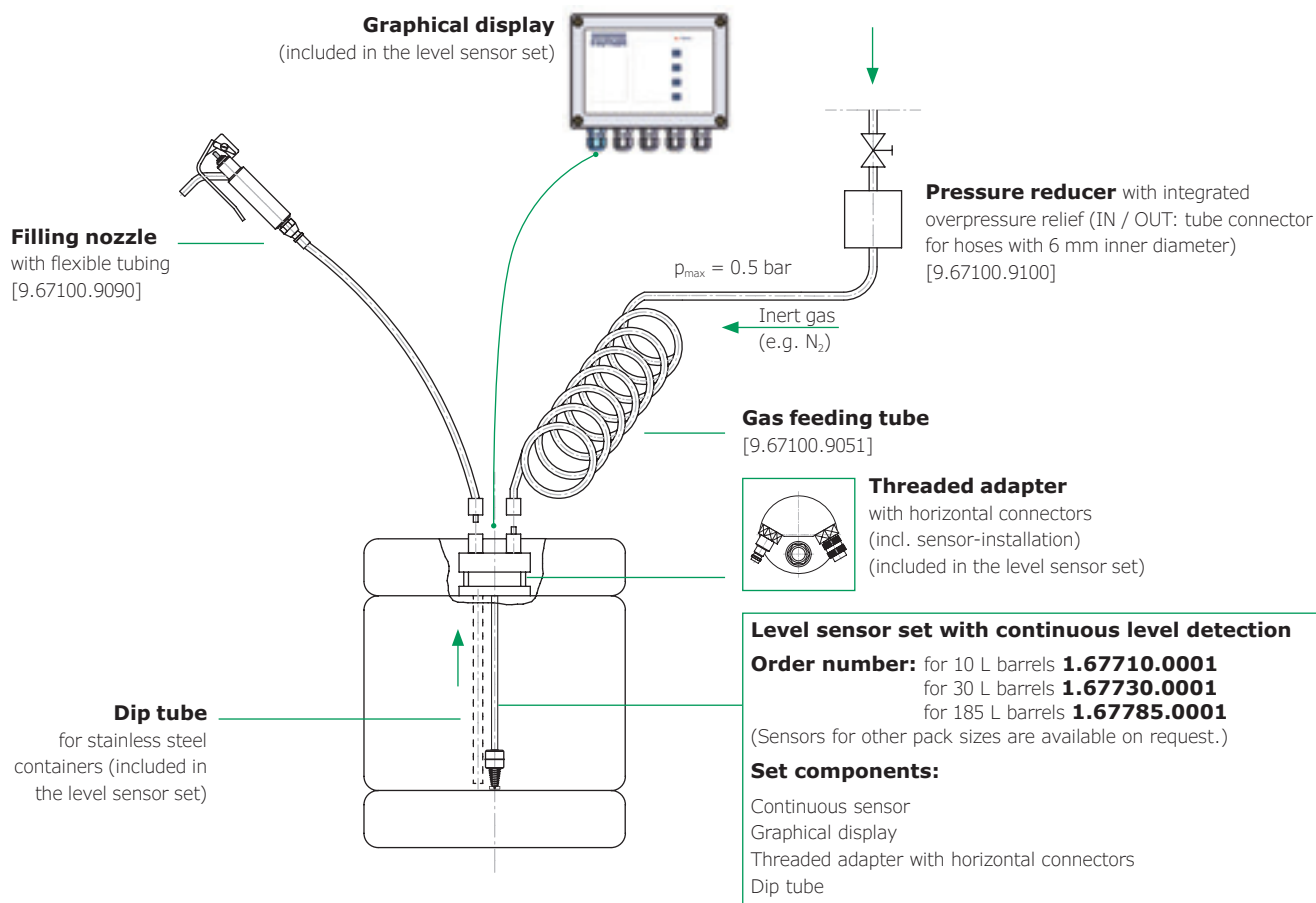

Maximum safety and reliability for your daily work

Continuous level sensor technology with ATEX approval provides maximum safety and reliability for your daily work. The graphical display always shows the exact solvent level inside the container. With adjustable alarm, individual management, measurement and control of solvent supply and disposal now are available and automatable, e.g. by visible control alarms or automatic control of HPLC instruments.

The new Merck sensor facilitates the complex functionality of automated solvent handling: Pre-assembled for each pack size and convenient to install. By using the filling nozzle and the gas feeding tube the direct withdrawal can start immediately. For customized installations please contact your local supplier to get direct and individual support.





Customized installations

[available for drums, barrels and containers]

Where large volumes of solvent are turned around, delivery from a central safety cabinet directly to the points of use (e.g. laboratory fume hood) through a permanent supply circuit is one of the most rational ways of working.

As the pioneer in developing high professional and innovative safety equipment for solvents (e.g. level sensors) we are always able to provide additional options for sustainable process automation and highest possible lab safety.

In a cooperative process we develop – together with you – the optimum solution for your individual application and environment.

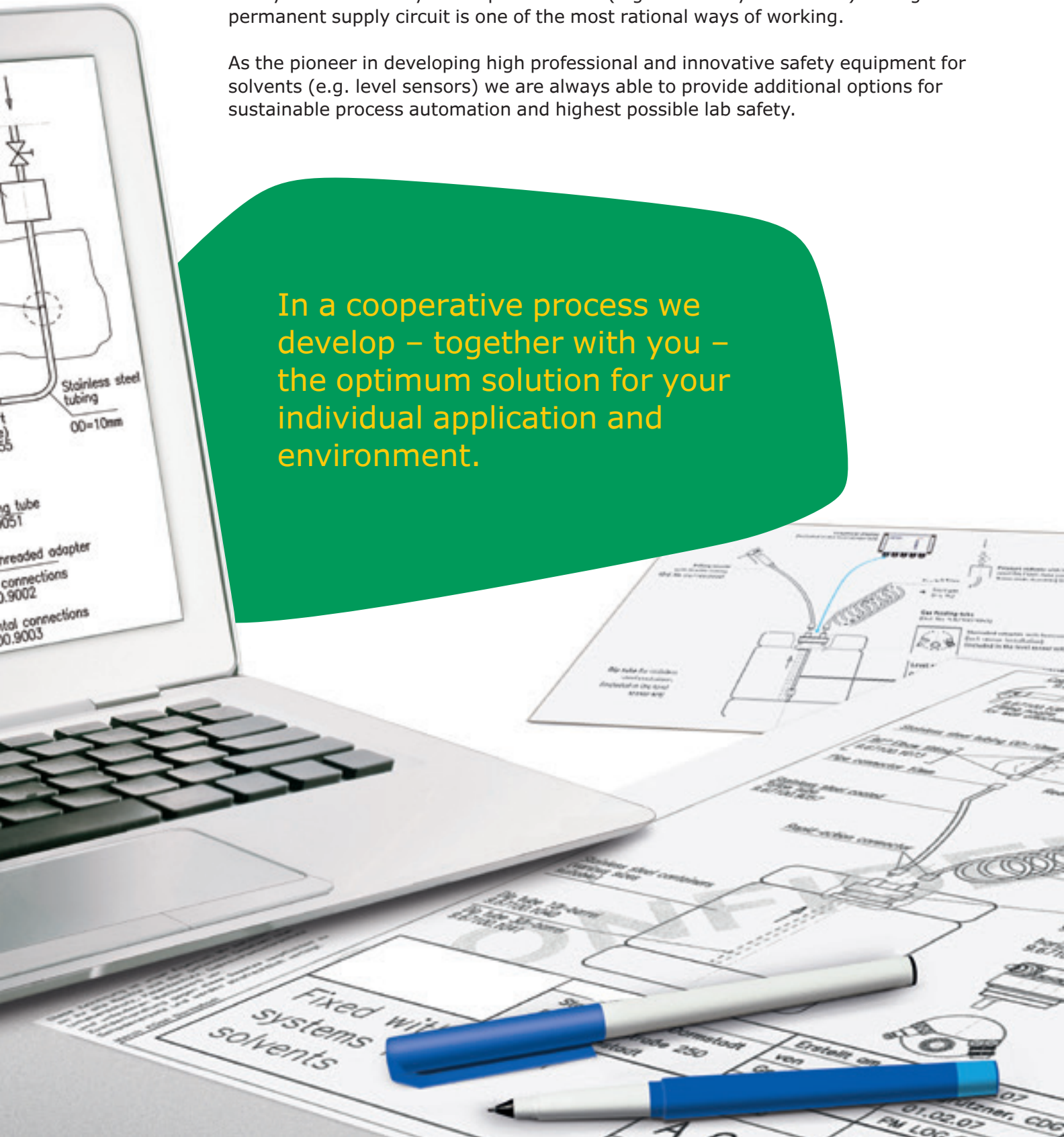

For more information ...

www.merckmillipore.com/solvents-withdrawal

Please do not hesitate to ask your local Merck supplier for your individual installation.

Technical drawings of our various standard installations provide a first impression of the various installation options.

We also recommend alternative products for maximum flexibility, e.g. special product developments when space is limited in your lab.

An extensive Merck product range of adapters and special connectors meets almost every individual installation requirement. If any product is not available directly from Merck, we recommend suitable products from reputable suppliers so that you always will receive complete installation recommendations from us.





Ordering information









Safety accessories for bottles

Categories	Products	Ord. No.
Connection screw caps	 Adapter S40 for the direct aspiration of solvents through tubes of 3 mm O.D. from bottles with S40 thread (4 openings)	1.09996.0001
	 HPLC bottle adapter with 3 tube connections ID 3.2 mm, solvent supply by Merck bottles	1.03830.0001
	 HPLC bottle adapter S40 with 3 tube connections and 1 connection for exhaust air filter, solvent disposal	1.03831.0001
	 Air valve for HPLC bottle adapter S40, supply (pack of 10)	1.03832.0001
	 Exhaust air filter for HPLC bottle adapter S40, disposal	1.03833.0001
	 Fittings for capillaries with 3.2 mm O.D., for HPLC bottle adapter S40 (pack of 10)	1.03834.0001
	 PTFE ferrule for capillaries with 3.2 mm O.D., for HPLC bottle adapter S40 (pack of 10)	1.03835.0001
	 Blanking plug for capillary connections with 3.2 mm O.D., for HPLC bottle adapter S40 (pack of 10)	1.03836.0001
Labels	 Label set according to GHS with 20 blank adhesive labels 80 x 110 mm, 168 adhesive hazard pictograms, 40 adhesive signal words, package insert with H- and P-statements	1.00801.0001
	 Adhesive Labels (pack of 100)	1.08899.0001
Level sensors	 Adapter with S40 thread and level sensor for emptying Merck solvent bottles	9.67100.2001
	 Adapter with S40 thread and sensor for filling Merck bottles	9.67100.2002
	 Display and alarm device for bottle level sensor	9.67100.2004
Opening tools	 Bottle key for opening and closing bottles with S40 and S28 screw caps	1.08801.0001
Safety carrier	 Safety carrier for Merck 2.5 L glass bottles	9.20078.0001
	 Safety carrier for Merck 4 L glass bottles	1.40140.0001

Withdrawal systems for bottles













Categories	Products	Ord. No.
Withdrawal systems	 Withdrawal system for solvents with manual pressure build-up in Merck bottles	1.78178.0001
Spare parts and optional products for withdrawal systems	 Conductive tubing for withdrawal system 1.78178.0001, length 40 cm (pack of 5)	1.78179.0001

Safety accessories for barrels and drums

Categories	Products	Ord. No.
Essential safety equipment	 Antistatic device for earthing metal containers when dispensing and filling flammable solvents (set of 3 cables)	1.07070.0001
	 Pressure safety device 0.5 bar with 2 tube connections (6 x 8 mm)	9.67100.9004
	 Reducing valve 0.2 bar with 2 tube connections (6 x 8 mm and integrated excess pressure safety device 0.5 bar)	9.67100.9100
Filling nozzle clamps	 Stainless steel clamp for filling nozzles for drum attachment	9.67106.0001
	 Stainless steel clamp for filling nozzles for wall attachment	9.67107.0001
Labels	 Label set according to GHS with 20 blank adhesive labels 80 x 110 mm, 168 adhesive hazard pictograms, 40 adhesive signal words, package insert with H- and P-statements	1.00801.0001
	 Adhesive Labels (pack of 100)	1.08899.0001
Level sensors	 Continuous level sensor for solvents in 10 L stainless steel barrels	1.67710.0001
	 Continuous level sensor for solvents in 30 L stainless steel barrels	1.67730.0001
	 Continuous level sensor for solvents in 185 L stainless steel barrels	1.67785.0001
Opening tools	 Drum key for opening and closing containers with 2" and 3/4" screw caps	1.08803.0001

Ordering information

Withdrawal systems for barrels and drums

Categories	Products	Ord. No.
Withdrawal systems	 Withdrawal system for solvents with manual pressure build-up for 10 L and 30 L stainless steel barrels with 2" opening	1.01123.0001
	 Withdrawal system for solvents with manual pressure build-up for 10 L and 25 L stainless steel drums with 2" opening	1.01114.0001
	 Withdrawal system for solvents with manual pressure build-up for 200 L barrels and drums	1.19171.0001
	 Withdrawal system for stainless steel barrels and drums with threaded adapter and flexible lines for gas pressurizing (additionally necessary: dip tube suiting the particular type of container)	1.06710.0001
Spare parts and optional products for withdrawal systems	 Dip tube for 10 L stainless steel drums for withdrawal system Ord. No. 1.01114.0001	9.67100.1012
	 Dip tube for 25 L stainless steel drums for withdrawal system Ord. No. 1.01114.0001	9.67100.1028
	 Dip tube for 10 L stainless steel barrels for withdrawal system Ord. No. 1.01123.0001	9.67100.1011
	 Dip tube for 30 L stainless steel barrels for withdrawal system Ord. No. 1.01123.0001	9.67100.1029
	 Hand pump ball for withdrawal systems Ord. No. 1.01114.0001 and 1.01123.0001	9.67114.0000
	 Hand pump with rapid-action connector	9.67100.1079
	 Seal (O-Ring, 14 x 2.5 mm) for withdrawal systems Ord. No. 1.01114.0001 and 1.01123.0001	9.67100.1048
	 Seal (O-Ring, 56 x 3.6 mm) for withdrawal systems Ord. No. 1.01114.0001 and 1.01123.0001 and threaded adapter	9.67100.1047

Accessories for high volume containers

	Products	Ord. No.
	Stainless steel coupling AM 1/2 NF connection 1/2"	9.67100.1086
	Sampling unit (stainless steel)	9.67400.0001
	Blowing out adapter for sampling unit 9.67400.0001	9.67400.0002
	Sampling unit for 1000l-container with Seliger-coupling	1.67400.0001
	Stainless steel coupling Seliger to G1" inner thread	1.67402.0001













Withdrawal components for individual installations

Categories	Products	Ord. No.
Adapters and reducers	Adapter (PE) K5 55 x 5 (inner thread) to S40 (outer thread) *	1.67208.0001
	Adapter (PE) KS 60 x 6 (inner thread) to S40 (outer thread) *	9.67203.0000
	Adapter (PTFE) GL45 (inner thread) to S40 (outer thread) *	1.67216.0001
	Bottle adapter (PTFE) S40 (bottle thread) to GL45 (outer thread) *	1.67206.0001
	Bottle adapter (PTFE) S40 (bottle thread) to S38 (outer thread)	1.67207.0001
	Coupling part between tube (6 x 8 mm) and pipe (O.D. 10 mm)	9.67100.1055
	Rapid-action connection nipple (gas side) with G3/8 thread	9.67100.1051
	Rapid-action connector for gas feed tube (8 x 6 mm) or for system venting	9.67100.1052
	Rapid-action connector for product tube 3 x 1.5 mm	9.67100.1076
	Rapid-action connector (product side) with G3/8 thread	9.67100.1050
	Rapid-action nipple for product tube 8 x 6 mm	9.67100.1061
	Rapid-action nipple with tube connection 6 x 4 mm	9.67100.1064
	Reducer (PE) from S40 to GL45	9.67206.0001
	Reducer (PE) from S56 x 4 to 2" thread (2" coarse to 2" fine thread)	9.67202.0000
	Reducer (stainless steel) from 2" to 3/4" thread	9.67204.0000
Reducer (stainless steel) from 2" to S40 thread	1.01111.0001	







* Image similar

Ordering information

Withdrawal components for individual installations [continued]

Categories	Products	Ord. No.
Filling nozzles and taps	 Filling nozzle (stainless steel) self-closing, with stainless steel-coated PTFE tube (80 cm) with rapid-action connector	9.67100.9090
	 Filling nozzle (tap), self-closing, with G3/8 thread	9.67100.1090
	 Filling nozzle (tap), self-closing, with G3/8 thread for wall attachment	9.67100.1084
Dip tubes	 Dip tube for 10 L stainless steel drum for withdrawal system with 2" thread adapter	9.67100.1010
	 Dip tube for 25 L stainless steel drum for withdrawal system with 2" thread adapter	9.67100.1025
	 Dip tube for 190 L stainless steel drum for withdrawal system with 2" thread adapter	9.67100.1190
	 Dip tube for 10 L stainless steel barrel for withdrawal system with 2" thread adapter	9.67100.1040
	 Dip tube for 30 L stainless steel barrel for withdrawal system with 2" thread adapter	9.67100.1041
	 Dip tube for 185 L stainless steel barrel for withdrawal system with 2" thread adapter	9.67100.1185
	 Dip tube for 25 L combi container for withdrawal system Ord. No. 1.01114.0001	9.67100.1026
Thread adapters	 Threaded adapter 2" (stainless steel) with 2 vertical rapid-action connectors	9.67100.9002
	 Threaded adapter 2" (stainless steel) with 2 horizontal rapid-action connectors	9.67100.9003

Withdrawal components for individual installations [continued]

Categories	Products	Ord. No.
Tubings	 Spiral gas feeding tube (Nylon) with rapid-action connector Rectus Type 21 (length: 180 cm, FFKM Sealing)	9.67100.9051
	 * Stainless steel-coated PTFE tube (80 cm) with rapid-action nipple and threaded connector G3/8	9.67100.9052
	 * Stainless steel-coated PTFE tube (80 cm) with 2 rapid-action connectors (1x coupling, 1x nipple)	9.67100.9058
	 * Stainless steel-coated PTFE tube (80 cm) with rapid-action coupling and pipe connector (O.D. 10 mm)	9.67100.9062
	 Stainless steel-coated PTFE tube (80 cm) with rapid-action connector and pipe connector (O.D. 10 mm)	9.67100.9057
	 * Stainless steel-coated PTFE tube (100 cm) with pipe connector (O.D. 10 mm) on both sides	9.67100.9061

* Image similar



Withdrawal system suitability



Ord. No.	Products	Stainless Steel Barrels			Stainless Steel Drums		
		10 L	30 L	185 L	10 L	25 L	190 L
1.06710.0001	Withdrawal system for stainless steel barrels and drums with threaded adapter and flexible lines, for gas pressure, necessary: dip tube suit the particular type of container dip tube additionally	+	+	+	+	+	+
		9.67100.1040	9.67100.1041	9.67100.1185	9.67100.1010	9.67100.1025	9.67100.1190
1.01123.0001	Withdrawal system for solvents with manual pressure build-up in barrels	+	+				
1.01114.0001	Withdrawal system for solvents with manual pressure build-up in drums dip tube information				+	+	
1.19171.0001	Withdrawal system for solvents with manual pressure build-up in 200l-barrels and drums			+			+

Connections for barrels & drums

Ord. No.	Products
9.67100.1050	Rapid-action connector (product side) with 3/8" thread
9.67100.1052	Rapid-action connector for gas feed tube (8x6 mm) or for system venting
9.67100.1051	Rapid-action connecting nipple (gas side) with 3/8" thread
9.67100.1061	Rapid-action connector for product tube (8 x 6 mm)
9.67100.1064	Rapid-action nipple with tube connection 6x4 mm
9.67100.1076	Rapid-action connector for product tube 3x1.5 mm
9.67100.1069	Hood wall duct with tube connector (OD 10 mm) for G 3/8 internal thread
9.67100.1055	Coupling part between tube (6x8 mm) and pipe (O.D. 10 mm)
9.67100.1073	Union elbow connector for metric tube to metric tube (o.d. 10 mm)
9.67100.1086	Stainless steel coupling AM 1/2 NF connection 1/2"
1.67402.0001	Stainless steel coupling Seliger to G1" inner thread
1.01111.0001	Reducer (stainless steel) from 2" to S40 thread
9.67204.0000	Reducer (stainless steel) from 2" to 3/4" thread



Metal Drums

10 L

25 L

25 L with PE-inliner
(combi drum)

180/190 L

180/190 L with PE-inliner
(combi drum)

+

+

+

shorten 10l-dip tube by 17 mm

shorten 25l-dip tube by 9 mm

use alternative dip tube
9.67100.1026

+

female Type 21
male type 21
G 3/8 outer thread
G 3/8 inner thread
pipe connector 10 mm
stainless steel pipe 10 mm
tube connector for 3x1.5 mm
tube connector for 6 x 4 mm
tube connector for 8 x 6 mm
1/2" NPT inner thread
Seliger
G1" inner thread
G2" outer thread
S40 outer thread
G3/4" outer thread
Coupling SPM08
(1000l container)

	x		x														
	x								x								
		x	x														
		x							x								
		x						x									
				x		x											
					x				x								
					2x												
										x							x
										x	x						
												x	x				
												x		x			

Tubings

Ord. No.	Products	female Type 21	male type 21	G 3/8 outer thread	G 3/8 inner thread	pipe connector 10 mm	tube length 80 cm	tube length 100 cm	filling nozzle
9.67100.9051	Spiral gas feeding tube (Nylon) with rapid-action connector, FFKM sealing, length 180 cm	x							
9.67100.9052	Stainless steel-coated PTFE-tube (80 cm) with rapid-action nipple and threaded connector G 3/8		x		x		x		
9.67100.9056	Stainless steel-coated PTFE-tube (80 cm) with 3/8" threaded connector and pipe connector (O.D. 10 mm)				x	x	x		
9.67100.9057	Stainless steel-coated PTFE-tube (80 cm) with rapid-action connector and pipe connector (O.D. 10 mm)		x			x	x		
9.67100.9058	Stainless steel-coated PTFE-tube (80 cm) with 2 rapid-action connectors (1x coupling, 1x nipple)	x	x				x		
9.67100.9061	Stainless steel-coated PTFE-tube (100 cm) with pipe connector (O.D. 10 mm) on both sides					2 x		x	
9.67100.9062	Stainless steel-coated PTFE-tube (80 cm) with rapid-action coupling and pipe connector (O.D. 10 mm)	x				x	x		
9.67100.9090	Filling nozzle (stainless steel) self-closing, with stainless steel-coated PTFE-tube and rapid action nipple		x						x

Bottle connections

Ord. No.	Products	PE	PTFE	S40 outer thread	G2" coarse outer thread	G2" fine inner thread	GL45 outer thread	GL45 inner thread	S38 outer thread	KS55x5 inner thread	KS60x6 inner thread	S40 inner thread
9.67203.0000	Reducer (PE) from KS60x6 (inner thread) to S40 (outer thread)	x		x							x	
9.67202.0000	Reducer (PE) from S 56X4 to 2" thread (2" coarse to 2" fine thread)	x			x	x						
9.67206.0001	Reducer (PE) from S40 To GL45	x					x					x
1.67206.0001	Bottle adapter (PTFE), S40 (bottle thread) to GL45 (outer thread)		x				x					x
1.67207.0001	Reducer (PTFE) from S40 to S38		x						x			x
1.67208.0001	Adapter KS55x5 (inner thread) to S40 (outer thread)	x		x						x		
1.67216.0001	Bottle adapter GL45 (inner thread) to S40 (outer thread)		x	x			x					
9.67207.0001	Reducer (PE) from S40 to S38	x							x			x

DISCLAIMER

Our withdrawal systems and safety accessories have been developed and optimized for the use with containers and chemicals from Merck KGaA, Darmstadt, Germany. Merck KGaA, Darmstadt, Germany therefore disclaims any warranty or liability for the operability of its withdrawal systems and safety accessories in connection with containers or chemicals from other manufacturers.

Merck KGaA, Darmstadt, Germany reserves the right to refrain from the delivery of withdrawal systems and safety accessories if the respective order does not indicate that each withdrawal system and safety accessory will be used in combination with appropriate chemicals and containers from Merck KGaA, Darmstadt, Germany.

We inform and advise our customers to the best of our knowledge and ability but without any engagement or liability on our part. Our customers must obey all existing laws and regulations. This also applies in respect of any protected rights of third parties. Our information and advice does not eliminate the need for our customers to check, on their own responsibility, that our products are suitable and safe for the purpose envisaged.

Supelco®

Analytical Products

Merck KGaA
Frankfurter Strasse 250
64293 Darmstadt, Germany

MerckMillipore.com

To place an order or receive technical assistance in Europe, please call Customer Service:

France: 0825 045 645

Spain: 901 516 645 Option 1

Germany: 069 86798021

Switzerland: 0848 645 645

Italy: 848 845 645

United Kingdom: 0870 900 4645

For other countries across Europe, please call: +44 (0) 115 943 0840

Or visit: **MerckMillipore.com/offices**

For Technical Service visit: **MerckMillipore.com/techservice**

© 2018 Merck KGaA, Darmstadt, Germany and/or its affiliates. All Rights Reserved. Merck, the vibrant M, EMPARTA, EMPLURA, EMSURE, LiChrosolv, MagniSolv, Prepsolv, SeccoSept, SeccoSolv, SupraSolv, UniSolv and Uvasol are trademarks of Merck KGaA, Darmstadt, Germany or its affiliates. All other trademarks are the property of their respective owners. Detailed information on trademarks is available via publicly accessible resources.

Lit. No. MK_BR2712EN
2017 - 04976
09/2018