

MISSION[®] RNAi Tools

Depend on our
comprehensive
shRNA & miRNA
portfolio

From screening to validation

- Libraries
- Panels
- Custom cloning

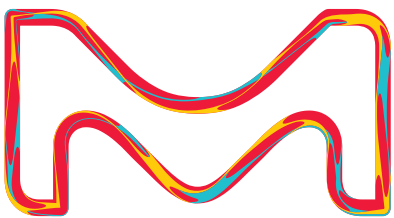

The life science
business of Merck
operates as
MilliporeSigma in
the U.S. and Canada.

Sigma-Aldrich[®]
Lab & Production Materials

Contents

Introduction to RNA Interference	3
MISSION® shRNA Library Screening	4
MISSION® TRC Lentiviral shRNA Libraries	5
MISSION® shRNA Gene Family Sets	5
shRNA LentiPlex® Lentiviral Pooled Libraries	6
Custom shRNA Pools	6
MISSION® Lentiviral Controls	7
MISSION® shRNA Controls	8
MISSION® Lentiviral Packaging Mix	8
Deconvolution	9
Individual MISSION® shRNA Clones	9
MISSION® shRNA Custom Cloning, Lentiviral Manufacturing and DNA Purification Services ..	10
MISSION® Inducible shRNA	12
The MISSION® microRNA Portfolio	14
MISSION® microRNA Mimics	14
MISSION® Lenti microRNA Inhibitors	15
Choosing an RNAi Format	18

An Introduction to RNA Interference

RNAi (RNA interference) is a natural biological mechanism wherein siRNA (short interfering RNA) duplexes induce potent inhibition of gene expression (Figure 1). These siRNA duplexes are produced naturally when an enzyme, Dicer, cleaves long dsRNA (double-stranded RNA) into smaller fragments. The resulting 21-23 nucleotide dsRNA fragments, i.e. siRNA, then associate with an RNase-containing complex to form the RISC (RNA-induced silencing complex). The RISC unwinds the duplex and releases the sense strand. The RISC-bound antisense strand then serves as a guide for targeting the activated complex to complementary mRNA sequences. This results in subsequent mRNA cleavage and degradation. In effect, only catalytic amounts of siRNA are required for destruction of mRNA, resulting in the knockdown or silencing of the target gene and thereby diminished protein expression. Most importantly, synthetic siRNA can also be introduced into the cell to produce the same effect.

Synthetic miRNA mimics can also be used to induce the RNAi pathway rather than directly using the standard 21 bp siRNA sequence. These synthetic forms of miRNA, termed short hairpin RNAs (shRNAs), are recognized and cleaved by Dicer to form siRNA that is subsequently taken up by RISC for silencing of the target gene.

Benefits of using RNAi

- Easy one step delivery
- Use multiple constructs or clones per gene
- Tunable knockdown of essential genes
- Easy delivery for cell lines, primary cells and *in vivo*
- Reversible
- Validated and exclusive shRNA collection

When you partner with our MISSION® RNAi team, you gain access to the extensively validated genome-wide shRNA libraries from The RNAi Consortium (TRC), flexible lentiviral shRNA custom services, and ideal screening formats designed to accelerate your research using RNAi. Take advantage of the MISSION® team's world-class expertise in high-throughput lentiviral manufacturing and DNA purification, our services can save you time and resources.

The RNAi Consortium (TRC) is a public-private consortium based at the Broad Institute which develops RNAi technologies to aid human and mouse gene functional genomics research. With TRC, we provide the MISSION® shRNA Library for human and mouse genomes which comprises the TRC1, TRC1.5 and TRC2 collections.

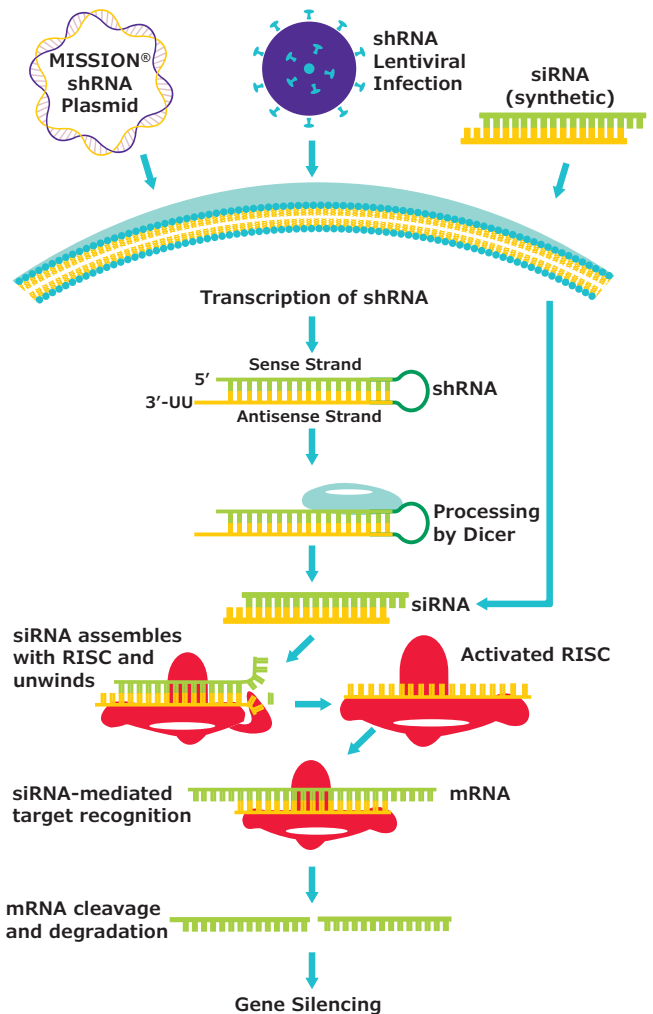

Figure 1. shRNA and siRNA mediated gene silencing. Cells may be directly transfected with MISSION® shRNA plasmids for transient or stable gene silencing, while shRNA lentiviral particles may be used to transduce the cell line of interest. Following transcription of the shRNA in the nucleus, the hairpin enters the RNAi pathway when it is cleaved by Dicer to generate siRNA. The siRNA is recognized by RISC, which mediates cleavage of the target mRNA for gene silencing. Synthetic siRNA may be directly transfected and enters the RNAi pathway when it assembles with RISC.

The TRC1.5 content (which includes the TRC1 collection) and TRC2 shRNA libraries are available exclusively from Sigma-Aldrich® advanced genomics to provide you with unparalleled gene coverage. As a collaborative member and distributor of the TRC collection, we offer multiple formats of these lentivirus-based shRNA libraries. Whole-genome TRC shRNA libraries, individual RNAi clones/vectors, or shRNA gene family sets (gene panels) are available in the standard glycerol format as well as the higher quality DNA and lentiviral formats.

MISSION® shRNA Library Screening

The Largest and Most Validated shRNA Collection from The RNAi Consortium

When performing RNAi in non-transfectable or non-dividing cells, you need efficient, long-term knockdown and a robust, quality system.

Lentivirus is widely used to deliver shRNAs to target cells because it can provide long-term gene silencing with high delivery efficiency. Our pLKO vectors—developed by TRC at the Broad Institute of MIT and Harvard—are designed to enable transduction of primary and non-dividing cell lines and facilitate creation of stable knockdowns (via introduction of antibiotic resistance genes).

Comprehensive TRC content

Pre-cloned genome-wide libraries: ~250,000 clone shRNA library targeting 20,000+ human and 21,000+ mouse genes. With ~5 clones per gene, the target coverage allows for multiple replicants, transcript specific targeting, and provides the most confidence in your shRNA knockdown phenotypes (**Figure 2**).

High-throughput manufacturing

Take advantage of our versatile manufacturing platform for high-throughput or large-scale viral production. Our robust and optimized processes save time and reduce variability in your transduction experiments. The MISSION® TRC shRNA collection is provided in 200 µL aliquots at 1 x 10⁶ VP/mL. Larger scale or higher titer specifications can also be accommodated.

Flexible format options

Entire libraries or single gene sets offered in glycerol stock, DNA, or viral format.

The Trusted MISSION® shRNA Library

The MISSION® shRNA Library is exclusive to the Sigma-Aldrich® portfolio and contains almost 250,000 TRC clones, of which more than 80,000 have been validated.

The MISSION® shRNA Library includes all the TRC content

Library	No. Clones	No. Genes	No. Validated Clones (% Validated)
Human TRC1	80301	16013	24119 (30)
Human TRC1.5	26554	6551	3903 (14.7)
Human TRC2	21056	5334	15031 (71.4)
Mouse TRC1	77350	15991	20,485 (26.5)
Mouse TRC1.5	12591	4116	214 (1.7)
Mouse TRC2	27543	6419	15885 (57.7)

*TRC1 and 1.5 have the same vector backbone. TRC2 has a WPRE element, which may increase marker expression and improve titer (see **Figure 4**).

Extensive Clone Coverage

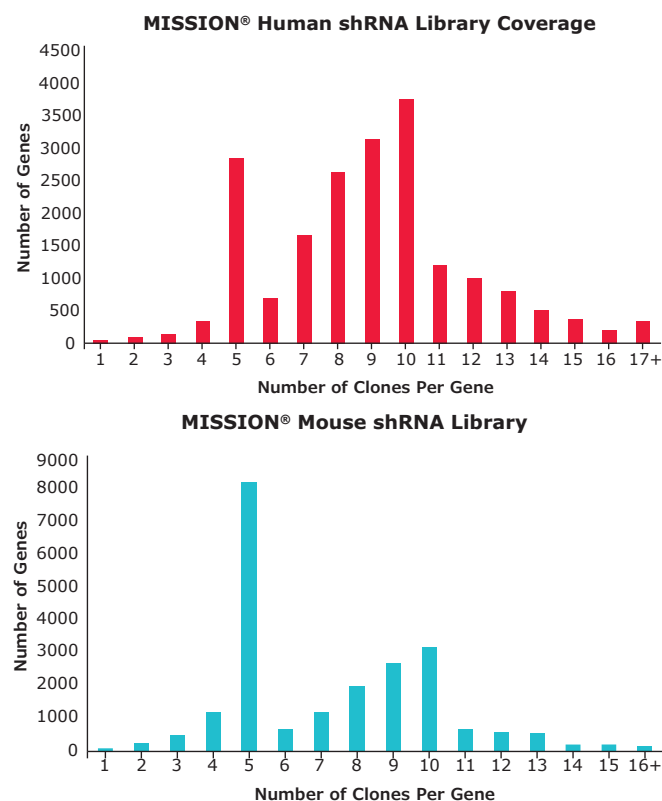

Figure 2. Number of gene vs. number of clones per gene for the MISSION® mouse and human libraries.

How to Order

Use our search tool to find your shRNA target at [SigmaAldrich.com/shRNA](https://sigmaaldrich.com/shRNA)

Guarantee:

Sigma-Aldrich® shRNA is guaranteed that upon purchase of the defined lentiviral clone set quantity on the shRNA product page for your gene of interest (this varies, but is typically 5 clones), that at least one of those lentiviral clones for a gene should yield greater than 70% knockdown.

For more information on our vast TRC library collection, visit [SigmaAldrich.com/shRNAlibrary](https://sigmaaldrich.com/shRNAlibrary)

MISSION® TRC Lentiviral shRNA Libraries

Dive into shRNA Screening

Our powerful and unique screening formats leverage the discovery potential of the trusted and proven TRC shRNA collection. When you partner with us, you gain access to our world class lentiviral production expertise and the formats you require for systematic or pooled RNAi screening on any scale. From the LentiPlex® pooled whole genome lentiviral shRNA library to individual clones, we offer the complete spectrum of shRNA tools to get you started screening today.

Sigma-Aldrich® advanced genomics offers libraries in glycerol, plasmid and viral formats. Our custom cloning group can also help you create the perfect custom arrayed or pooled library to fit your needs.

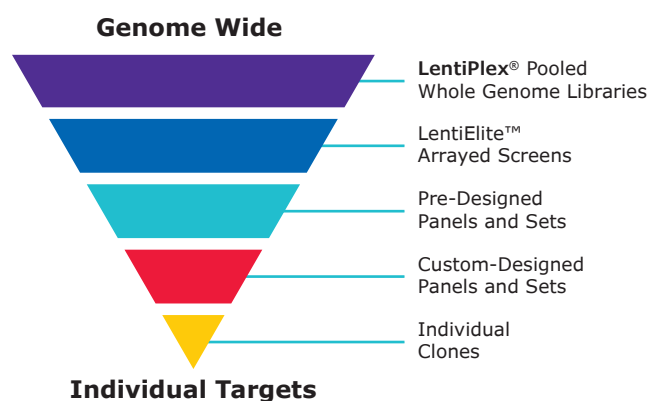

Choose the Screen that Fits Your Research

	Cat. No.	Content	Format
			Arrayed – Single shRNA per well
			Pooled – Multiple shRNAs per well
LentiPlex® Library	SHPHLIBR SHPMLIBR	whole genome, human whole genome, mouse	Pooled*
LentiElite™ screens and pre-designed arrayed panels	Custom**	focused gene collections, human or mouse	Arrayed
Custom-designed Panels and Pools	Custom**	your gene list, any species	Arrayed or pooled*

*Note: Identification of shRNA hits/leads within a pooled shRNA screen requires deconvolution using high-throughput sequencing, microarrays or FACS analyses.

**TRC1.5 and TRC2 content in pooled LentiPlex® format available on request.

MISSION® shRNA Gene Family Sets

Our shRNA library gene family sets are collections of genes related to specific cellular/molecular pathways documented in NCBI, Gene Ontology (GO), Protein Lounge, and Ingenuity Systems. Our bioinformatics team has methodically mapped all TRC shRNA clones to each set. Gene family sets are fully customizable allowing for complete flexibility to add or delete clone or gene content. Additionally, any panel can be arrayed in either 96- or 384-well plate formats. All of the gene family sets can be used at the benchtop for focused target discovery and pathway analysis.

Sets include G-Protein Coupled Receptors, Kinases, Nuclear Hormone Receptors, Phosphatases, Tumor suppressors, Ubiquitin Ligases, T-Cell Activation, B-Cell Activation, p53 Pathway, and many more.

Visit SigmaAldrich.com/GeneFamilies

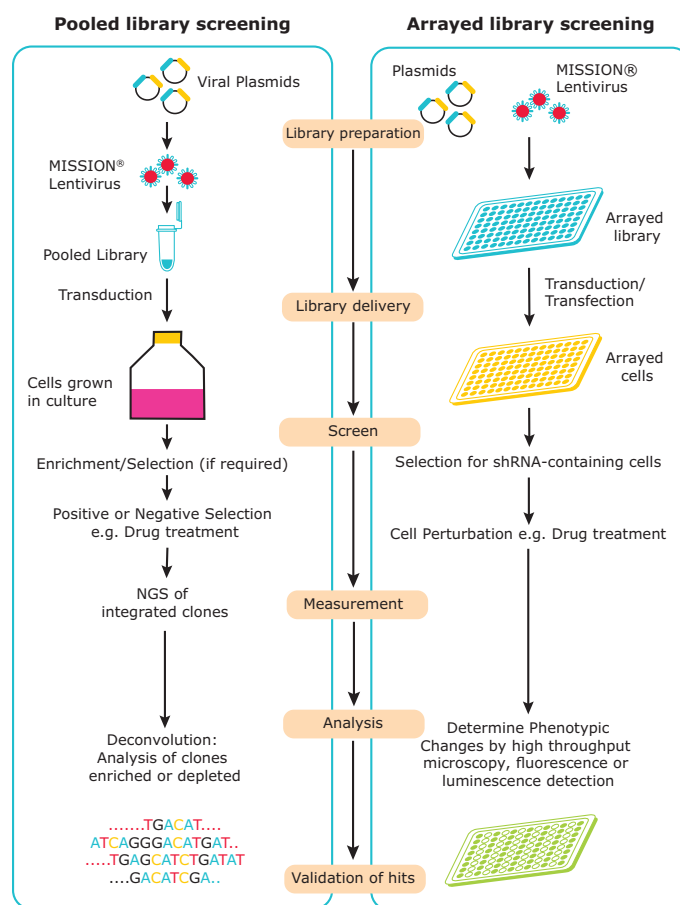

Figure 3. Pooled vs. arrayed screening workflows

MISSION® shRNA LentiPlex® Lentiviral Pooled Libraries

In addition to the complete libraries, we also offer more manageable LentiPlex® lentiviral shRNA pools to enable you to carry out genome-wide RNAi screens at your benchtop with minimal reagent, time or capital equipment investment.

What are LentiPlex® shRNA Libraries?

- A complete species-specific shRNA collection of ~80,000 (over 20,000 validated) shRNA clones harbored in ten subpools
- Extensive coverage supplying an average of 5 shRNA clones per gene
- Each subpool consists of 2 × 25 µL aliquots of VSV-G lentivirus concentrated at 5 × 10⁸ VP/mL
- Sequencing and amplification primers are included to expedite your downstream hit analysis
- Available for either human or mouse genome screening

LentiPlex® Content

Cat. No.	Product Name	No. Clones	No. Genes	No. Validated Clones (% validated)
SHPH01	LentiPlex® Human Pooled Library	81,824	18,970	24,305 (30)
SHPHLIBR	LentiPlex® Human Whole Genome Library	129,424	20,060	42,655 (33)
SHPM01	LentiPlex® Mouse Pooled Library	77,721	17,893	20,501 (26)
SHPMLIBR	LentiPlex® Mouse Whole Genome Library	117,841	20,642	36,604 (31)

MISSION® Custom shRNA Pools

Create your own custom shRNA pooled library from a vetted collection of vectors and the largest portfolio of validated shRNA constructs.

Rapid, Convenient shRNA Screens

- Focus on the genes essential to your research by creating your own custom pool
- Pools can be arranged in functional categories for maximum return of relevant hits
- Customize your volume and aliquoting needs to further enhance your ability to rapidly screen multiple cell lines
- Titers and volumes adequate for *in vitro*, *in vivo* and xenograft applications
- We provide next-generation library prep, sequencing, and analysis for data deconvolution
- Functional titer assays: FACS or CFU

To place an order, contact us at MISSIONRNAi@sial.com

Maximize Lentiviral Transduction

Enhance your transduction with the ExpressMag® transduction system to further improve lentiviral-based delivery to non-transfectable cells. The ExpressMag® system concentrates virus near the cell resulting in transduction at higher efficiencies, transduction of hard-to-transduce cell types (e.g. primary cells, stem cells or T Cells), and reduction of transduction time. SigmaAldrich.com/ExpressMag

Cat. No.	Product Name
SHM03	MISSION® ExpressMag Beads
SHM04	MISSION® ExpressMag Super Magnetic Plate
SHM05	MISSION® ExpressMag 96-Well Magnet

MISSION® Lentiviral Controls

For All Your Experimental shRNA Needs

Your unique approach to screening can lead to variations in results, which need to be controlled for. We have a range of vectors available to make sure that your controls are accurate and appropriate for your system.

Whether you need controls for color, alternate promoters, or higher titers, our collection has you covered:

- Ready to use—all the controls you need to move forward quickly with your experiments
- Alternate promoter transduction controls—for experiments in which CMV is silenced
- High titer controls—when you just need higher titers, available for our four most popular controls
- Our most popular controls in the pLKO-puro backbone:
 - Empty pLKO-puro vector
 - Non-Target shRNA control
 - TurboGFP-expressing transduction control
 - shRNA to TurboGFP control

Our two main vector backbones are TRC1.5-pLKO.1-puro and TRC2-pLKO.5-puro. There are 2 main differences between the two but the overall titer and function are similar (**Figure 4**). The pLKO.5 vector has been engineered with modular components flanked by unique restriction sites to aid molecular alteration of the backbone for other purposes (e.g. alternate selection markers, or fluorescent protein expression, alternate promoters, etc.). pLKO.5-puro contains a WPRE element 3' to the PGK-PAC cassette. This may have a slight improvement on titer and/or expression from the pol II promoter.

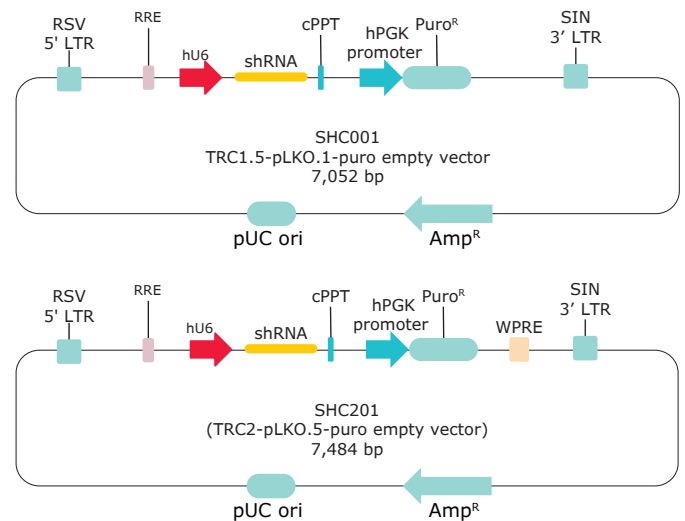

Figure 4. TRC1.5-pLKO.1-puro (SHC001) and TRC2 pLKO.5-puro (SHC201) empty vectors

These vectors can be adapted to meet your needs for any experiment. Some of the variations include:

Vector Category: shRNA Constitutive, shRNA Inducible

Pol II cassettes: PGK-Puro^R, PGK-Blast^R, PGK-Hygro^R, 2A-tGFP, 2A-mCd90 (thy1.1), 2A-eGFP, 2A-LacI

Pol III promoter: constitutive hU6, U6 inducible
1 x LacO, U6 inducible 3 x LacO

Selection Marker: Puro^R, Blast^R, Neo^R

Visible Reporter: tGFP, tRFP

MISSION® shRNA Controls

Our controls are set out in the following categories to help you choose the most appropriate controls for your shRNA experiments:

- **Positive controls for transduction.** We offer a large collection of positive controls to monitor multiplicity of infection (MOI).
- **Positive controls for knockdown.** Multiple positive controls to monitor knockdown. These are important for establishing the assay before carrying out screening or experimental monitoring.
- **Negative controls.** The use of several negative/non-targeting controls is critical for establishing background noise or off targeting in experimental assays and pooled screening.

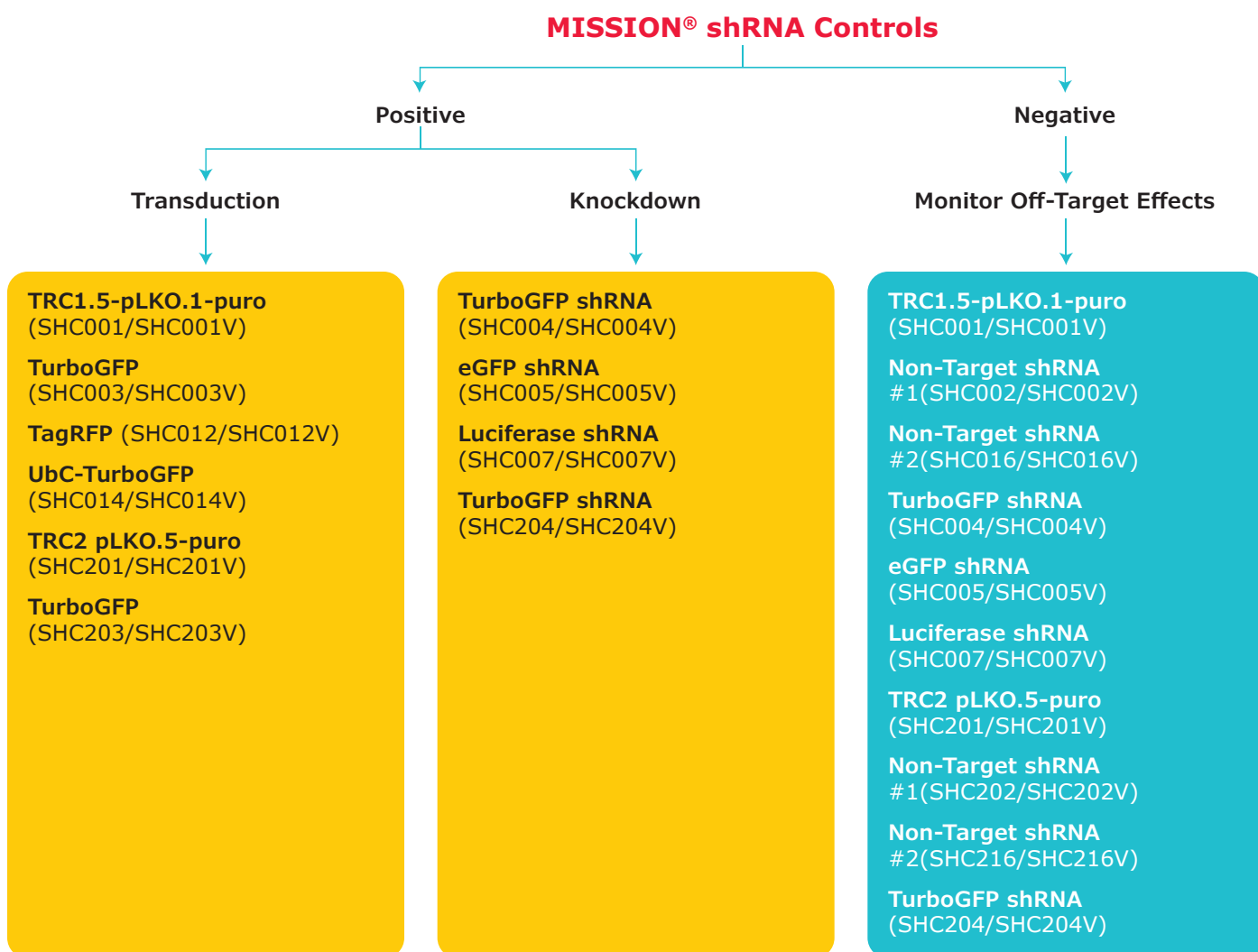

Learn more at SigmaAldrich.com/shRNAcontrols

MISSION® Lentiviral Packaging Mix

The MISSION® Lentiviral Packaging Mix is an optimized formulation of two plasmids expressing the key HIV packaging genes and a heterologous viral envelope gene. It is designed to be co-transfected along with a compatible lentiviral transfer vector in order to create high-titer pseudo-typed lentiviral particles used for downstream transduction applications. We

recommend our next generation lentiviral packaging mix (SHP002), but the original packaging mix (SHP001) is also available.

Cat. No.	Product Name
SHP001	MISSION® Lentiviral Packaging Mix
SHP002	CRISPR & MISSION® Lentiviral Packaging Mix

Deconvolution Services to Identify Hits from Pooled shRNA Screens

Next-Gen Sequencing for Deconvolution of shRNA Pools

- Easily identify the genes that impact your screen
- Next-generation sequencing of clones gives a precise number of individual clone occurrence within a pooled shRNA sample
- Comprehensive, reproducible results from pooled shRNA screens
- Statistically robust and information-rich data

Why Use Us as Your Deconvolution Partner?

- Quick turnaround of data (approx. 4 weeks)
- Consistency in DNA preparation and sequencing
- Cost effective due to the ability to multiplex samples on a single lane
- Experience with shRNA pool deconvolution of TRC1, TRC1.5 and TRC2 libraries; including simultaneous sequencing through our proprietary method
- Data provided in an easy-to-analyze format

DNA Preparation and Deconvolution Workflow

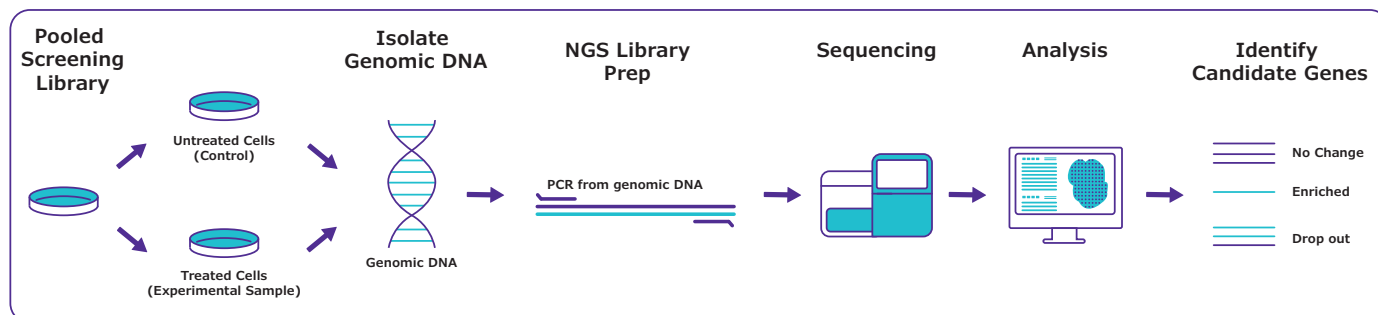

SigmaAldrich.com/Deconvolution

Why Use Next-Gen Sequencing Over Other Methods for Pooled Screen Deconvolution?

- Greater dynamic range
- Look for enriched or reduced shRNA
- No hybridization bias reduces false negatives
- No cross-hybridization reduces false positives
- Precise count of shRNA frequency
- Detects very low to high abundance shRNA
- Analyze multiple pools simultaneously
- Can be conducted on custom and genome-wide pools

Individual MISSION® shRNA Clones

Need to order a smaller amount of clones for individual targets? Our easy-to-use online ordering tool allows you to search by gene, view validation data and order clones in glycerol, plasmid DNA, and lentiviral formats. Choose from over 315,000 pre-cloned shRNAs targeting human and mouse genomes. Order 5 or more and receive a discounted price.

Visit SigmaAldrich.com/shRNA

MISSION® shRNA Custom Cloning, Lentiviral Manufacturing and DNA Purification Services

Start Your RNAi Experiments Today

Let the MISSION® team clone your shRNA into your vector of choice and then provide you with ready-to-use lentiviral particles.

Our rapidly growing vector menu is designed to meet your specific RNAi needs. Whether you need large-scale/high-titer virus, GFP or other fluorescent reporters, alternate selection markers, alternate promoters, inducible vectors, or cloning of your favorite shRNA sequence...we've got you covered.

- IPTG-inducible vectors as the latest development from our continued partnership with the TRC
- Focus on discovery—leave the laborious cloning and lentiviral production to the MISSION® shRNA Team
- Select by methods other than puromycin, including neomycin (G418) and FACS via reporters
- Guaranteed titer—in addition to DNA for your custom clones, we'll send you the virus titered to your specifications
- Confirm your lentiviral delivery through a fluorescent reporter
- Customize your shRNA sequence

Vector Backbone	Expression		Selection Method			Alternative to CMV promoter
	Constitutive	Inducible	Puromycin	Neomycin (G418)	Fluorescence	
pLKO.1-puro	X		X			X
pLKO.1-CMV-tGFP	X				X	
pLKO.1-puro-CMV-tGFP	X		X		X	
pLKO.1-CMV-Neo	X			X		
pLKO.1-Neo	X			X		X
pLKO.1-Neo-CMV-tGFP	X			X		
pLKO.1-puro-CMV-TagCFP™	X		X		X	
pLKO.1-puro-CMV-TagYFP™	X		X		X	
pLKO.1-puro-CMV-TagRFP™	X		X		X	
pLKO.1-puro-CMV-TagFP635™	X		X		X	
pLKO.1-puro-UbC-TurboGFP™	X		X		X	X
pLKO.1-puro-UbC-TagFP635™	X		X		X	X
pLKO-puro-IPTG-1xLacO		X	X			X
pLKO-puro-IPTG-3xLacO		X	X			X

MISSION® shRNA Custom Services Benefits

Pre-Sale Support:

- Consultations with R&D and manufacturing experts
- Complimentary shRNA design service for species other than human and mouse
- Bioinformatics support
- Custom gene family design
- Customer supplied vector cloning services

Post-Sales Support:

- Technical service team specially trained in RNAi
- Detailed specifications and quality control
- Troubleshooting with R&D and manufacturing experts
- Additional bioinformatics support

Inducible shRNA Vectors – Tight regulation meets great gene silencing. Regulating expression is especially important when studying essential and lethal genes

Titer up to 10⁹ VP/mL – Order any shRNA sequence in lentiviral format at titers from our standard 10⁶ VP/mL up to 10⁹ VP/mL (via p24 assay)

Large Volume – Get your favorite shRNA lentiviral particles in large volumes, up to 1.0 L depending on requested titer, instead of our standard 200 µL format

Alternatives to CMV Promoter – The CMV promoter, while yielding strong expression in many cell lines, may not function in certain cells. We currently offer vector backbones that use promoters other than CMV

Custom Cloning – shRNA sequences can be cloned into a wide selection of pLKO.1-based vectors

High-throughput DNA purification – Take advantage of our expertise from individual clone preps, panels, and pools to entire libraries

CUSTOM RNAi PRODUCTS & SERVICES

A variety of custom cloning options available

Generation of customized gene sets

High-throughput DNA purification

Deconvolution of complex shRNA pools

High-throughput lentiviral manufacturing

Large scale viral manufacturing from 1 mL to liters as well as customized viral packaging

Concentrated viral preparations up to 10⁹ VP/mL

Functional titer assays available - FACS or CFU

WHAT IS YOUR REQUEST?

How to Order

To place an order and for additional information on custom shRNA cloning, visit

SigmaAldrich.com/CustomCloning

MISSION® Inducible shRNA

Get the Entire MISSION® shRNA Library in an IPTG-Inducible Vector

Inducible Vectors from the RNAi Consortium (TRC)

Constitutively expressed shRNAs are useful for most RNAi needs, but further characterization often requires the ability to tune gene expression. Regulating expression is especially important when studying essential and lethal genes. We offer IPTG-inducible vectors as the latest development from our continued partnership with TRC. Trust in MISSION® Custom Services to create the perfect clone to fit your research.

Why Use IPTG-Inducible shRNA?

- Temporally controlled gene silencing useful for essential gene knockdown
- Proven to work *in vivo* and *in vitro*
- Single vector system for effective inducible knockdown
- Fast response time of IPTG induction
- Tight regulation and high induction of shRNA expression
- Comparable to TET-inducible systems (Figure 9)
- Available in the widely used TRC vector backbone
- Lentiviral delivery increases the number of targetable cell lines
- Developed at the Broad Institute by TRC

Customize your Inducible shRNA

- Vector: 1× LacO & 3× LacO
- Titer: 1×10^6 – 1×10^9 VP/mL
- Volume: 200 μ L - 10 mL
- Choose any TRC clone or custom sequence
- Get both DNA and virus for one great price

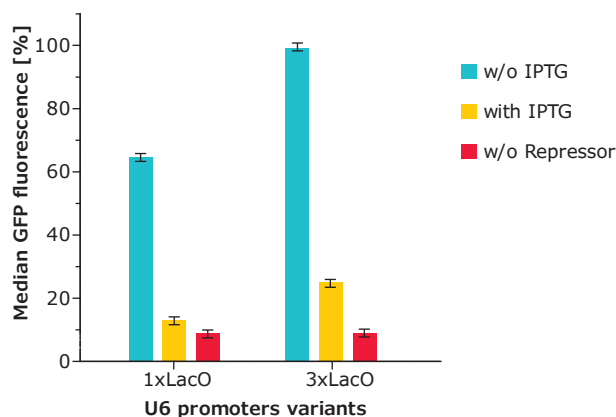

Figure 5. Comparison of inducible shRNA expression from different U6 promoters. Jurkat cells with stable GFP expression were infected with different vectors carrying an shRNA against GFP with and without repressor. All the cells were treated with 1 mM IPTG. The remaining GFP fluorescence was compared after 5 days. Cells infected with the empty vector control were used as a negative control. Values represent the mean and standard deviation of three independent experiments.

For more about the MISSION® IPTG-Inducible shRNAs, visit SigmaAldrich.com/Inducible

Cat. No.	Product Description
SHC314V	MISSION® 1x LacO Inducible TurboGFP™ shRNA Control Transduction Particles
SHC334V	MISSION® 3x LacO Inducible TurboGFP™ shRNA Control Transduction Particles
SHC317V	MISSION® 1x LacO Inducible Luciferase shRNA Control Transduction Particles
SHC337V	MISSION® 3x LacO Inducible Luciferase shRNA Control Transduction Particles
SHC312V	MISSION® 1x LacO Inducible Non-Target shRNA Control Transduction Particles
SHC332V	MISSION® 3x LacO Inducible Non-Target shRNA Control Transduction Particles

IPTG-inducible RNAi Vectors

The pLKO vector has been redesigned to contain LacI (repressor) and a modified human U6 shRNA promoter with LacO (operator). In the absence of IPTG (isopropyl-β-D-1-thiogalactopyranoside), an analog of lactose, the LacI repressor binds LacO operator preventing expression of the shRNA. When IPTG is added, the allosteric LacI repressor changes conformation allowing expression from the modified U6 promoter.

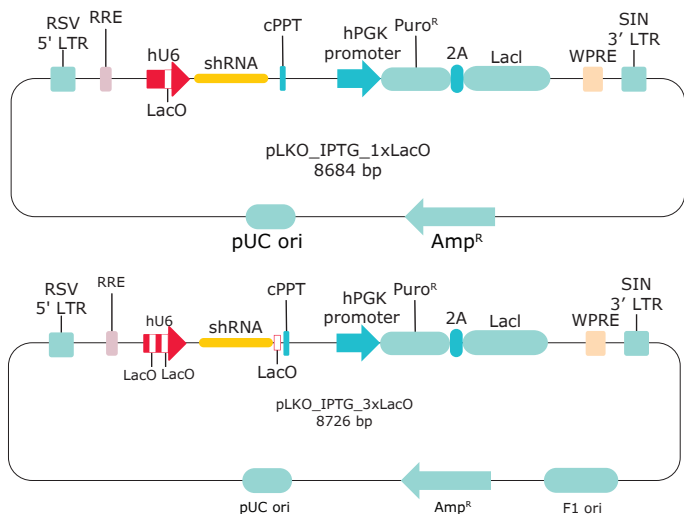

Figure 6. Inducible shRNA vector backbone maps

We offer two different IPTG vectors for your research (Figure 6). The preferred IPTG vector, pLKO_IPTG_3xLacO, contains three lac operon sequences (two in the U6 promoter and one 3' of the promoter) affording both tight regulation and great gene silencing. Whereas, the pLKO_IPTG_1xLacO vector contains a single lac operon sequence in the U6 promoter, which allows for an advantage to shRNA expression, but looser control of the promoter when not induced (Figures 7 & 8).

Gene Silencing Potency

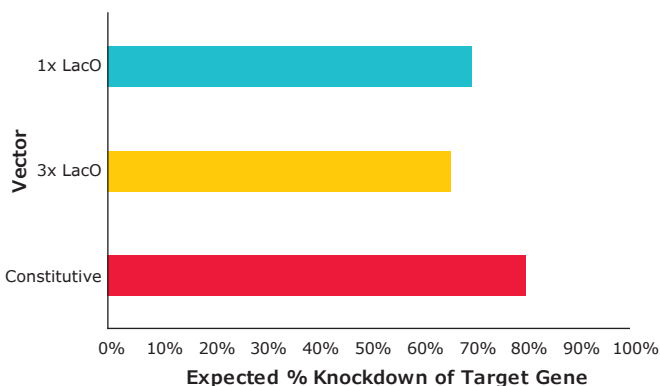

Figure 7. Inducible vs. constitutive vector gene silencing potency

Leakiness

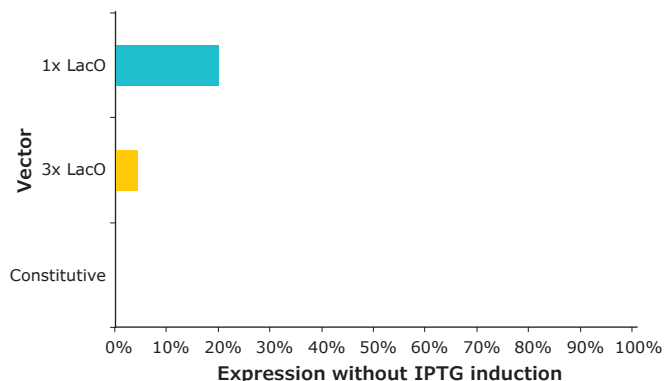

Figure 8. Inducible vs. constitutive vector leakiness

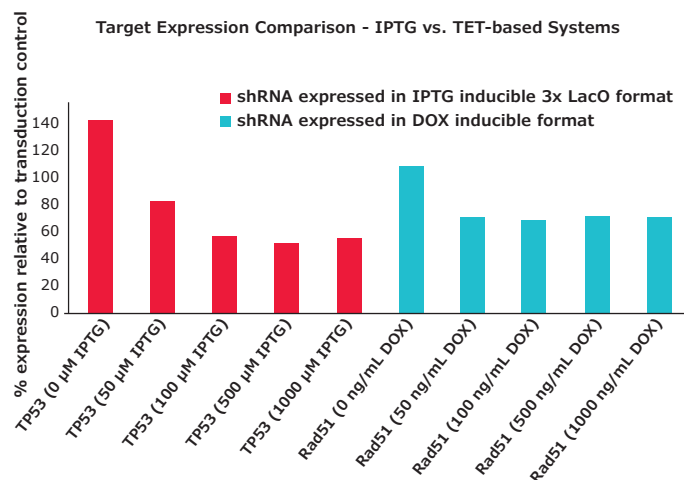

Figure 9. Comparison of IPTG- and TET-inducible shRNA-mediated knockdown. p53 and Rad51 were targeted for knockdown with either IPTG- or TET-based inducible systems, respectively. After optimization of viral MOI and shRNA sequence used, an induction curve was performed for each target using varied concentrations of IPTG or DOX, as indicated. Induction of shRNA expression was carried out for 48 hours, after which total RNA was harvested from the treated cells and target expression was measured by qRT-PCR. Percent expression shown is relative to untreated wild-type cells (HepG2 for p53 and A549 for Rad51), and is normalized to cyclophilin A expression. When no IPTG is present in the culture media, knockdown was not observed, yet very low levels of DOX were able to induce shRNA-mediated knockdown of Rad51. Further, upon induction with varied concentrations of IPTG, a more dynamic range and higher overall knockdown was observed, indicating higher sensitivity relative to TET-induced knockdown of Rad51.

The MISSION® microRNA Portfolio

Complete miRNA Solutions for Screening

Mature microRNAs (miRNAs) are naturally occurring, small non-coding RNA molecules, about 21–25 nucleotides in length. MicroRNAs are partially complementary to one or more messenger RNA (mRNA) molecules. The primary function is to downregulate gene expression in various manners, including translational repression, mRNA cleavage, and deadenylation. We have made a strong commitment to this area of research and have developed a comprehensive product portfolio to enhance your miRNA research.

Screening

MISSION® miRNA Human Mimics

- Most comprehensive collection of miRNA human mimics available
- Optimized and transfection ready
- Available as a complete library or as individual miRNA mimics

MISSION® Lentiviral miRNA Inhibitors

- Designed using a proprietary algorithm based upon the Tough Decoy (TuD) design
- Allows for potent inhibition of the desired miRNA

MISSION® microRNA Mimics

MISSION® miRNA Mimics are designed to enter the miRNA pathway and mimic mature miRNA. This enables you to confidently analyze miRNA function. Our MISSION® miRNA Mimics utilize a unique design and modification that reduces off-target effects.

miRNA Mimics are available in a ready-to-use miRBase version 17 library, or select from over 1,900 individual Mimics. Custom Mimics for all species are available, including the current miRBase version content.

Spend Your Time on Discovery:

- Functionally tested for knockdown efficiency
- Custom miRNA Mimics available
- >1,900 miRNA Mimics
- Quick delivery, ships within 2 business days
- Unique design reducing off-target effects

Human miRNA Mimic miRBase

The library includes 1,902 miRNA Mimics prepared in a convenient 96-well format. The two outside columns of each plate are empty for the addition of controls. Each miRNA Mimic is provided at 0.25 nmole/well and 2 non-targeting miRNA controls are included on each plate.

MISSION® miRNA Mimics significantly reduce known gene target expression

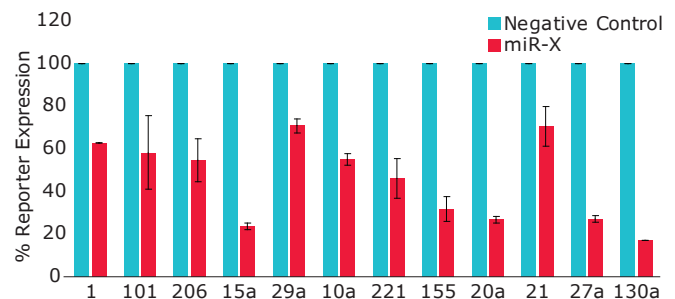

Figure 10. HeLa cells were co-transfected with MISSION miRNA Mimics and psi-CHECK2 Dual Luciferase Reporter Construct (Promega), containing corresponding miRNA target sequences. Constructs contained full length 3'UTR sequence-specific miRNA sequences (100% complementary to the mature miRNA). The MISSION® miRNA Mimic negative controls are non-human miRNAs, predicted to not target the human genome/transcriptome.

MISSION® miRNA Mimic design and modification

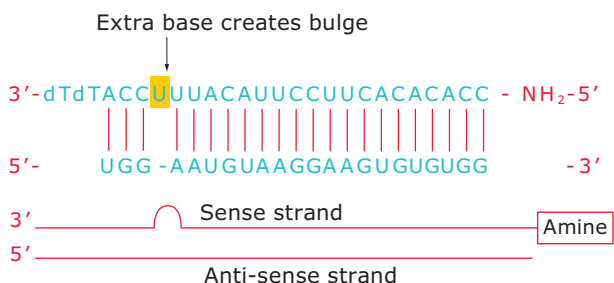

Figure 11: The unique design and modification of our MISSION® miRNA mimics significantly reduces possible sense strand off-target effects.

Reduction of passenger strand off-target effects

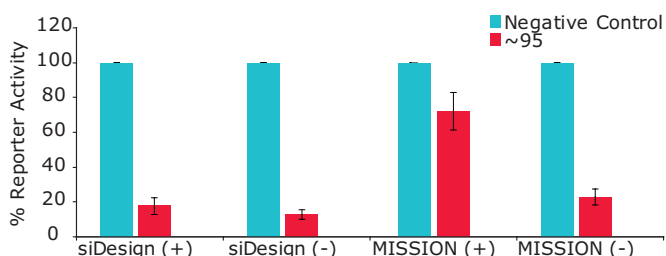

Figure 12. MISSION® human miRNA Mimic design (miRNA 206) was tested to measure possible passenger strand off-target effects. Passenger strands of the miRNA Mimic were either designed by traditional siRNA design (siDesign) with (+) or without (-) chemical modification, or by MISSION® miRNA Mimic Design with (+) or without (-) chemical modification. Reporter constructs contained targets that were ~95% complementary to the passenger strand sequence. Our MISSION® miRNA Mimics use a proprietary design and chemical modification to effectively reduce off-target effects.

Cat. No.	Description
HM10001-1920	Individual miRNA Mimics (5 nmole)
M100200	miRNA Mimic library (0.25 nmole)
HMC0002-0003	Controls (5 nmole)
Inquire	Custom miRNA Mimic (10 nmole)

How to Order

To place an order, or learn more about our miRNA product offering, visit

SigmaAldrich.com/miRNA

Selected Citations for microRNA Mimics

Humphreys, D.T., et al. Complexity of Murine Cardiomyocyte miRNA Biogenesis, Sequence Variant Expression and Function. *PLoS One*. 2012. 1-18.

Sun, L, et al. Low-dose paclitaxel ameliorates fibrosis in the remnant kidney model by down-regulating miR-192. *J. Pathol.* 2011. 255(3). 364-377.

Schultz, N. et al. Off-target effects dominate a large-scale RNAi screen for modulators of the TGF- β pathway and reveal microRNA regulation of TGFBR2. *Silence* 2011, 2:3

Elucidate miRNA Function with MISSION® Lenti microRNA Inhibitors

MicroRNA Inhibition in a Lentiviral Plasmid Vector

Inhibition of microRNAs is essential to studying their function. We offer a collection of individual microRNA inhibitors which are designed using a proprietary algorithm based upon the tough decoy (TuD) design. Each miRNA inhibitor construct has been cloned and sequence verified to ensure a match to the target miRNA.

MISSION® Lenti miRNA Inhibitor Design

Expression of the miRNA inhibitor is driven by the hU6 promoter upon genomic integration of the lentiviral transfer vector into the host cell post-transduction. miRNA inhibitors are able to competitively bind specific miRNAs and prevent them from regulating their endogenous targets.

Integrated lentiviral miRNA inhibitor cassette

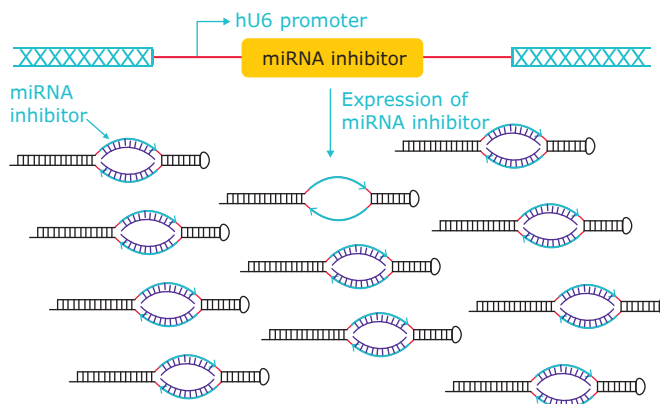

Figure 13. Lentiviral miRNA Inhibitor Expression Regulates miRNA Function

Benefits of MISSION® Lenti miRNA Inhibitors

- Allows for potent inhibition of desired miRNA
- Lentiviral format allows for efficient delivery of the inhibitor into a wide variety of cell types
- Enables long-term inhibition without repeat transfections

Validation of Lenti miRNA Inhibitors by Dual Luciferase Assay

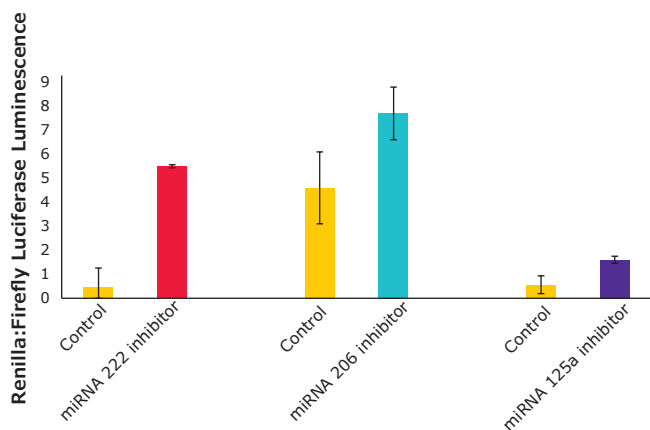

Figure 14. Dual Luciferase Assay: HeLa Lenti miRNA Inhibitor Cell Lines. HeLa cells were stably transduced with lentivirus harboring the miRNA inhibitors indicated. Stable pools were cultured for a minimum of two weeks and were then transfected with dual luciferase reporter constructs corresponding to the miRNA of interest. Ratios of Renilla:firefly luciferase luminescence were calculated for each cell line tested, and compared to control inhibitor cells. An increase in Renilla:firefly luminescence in inhibitor-expressing cells relative to controls cells indicates functionality of the inhibitor.

Higher MOI May Increase miRNA Inhibition

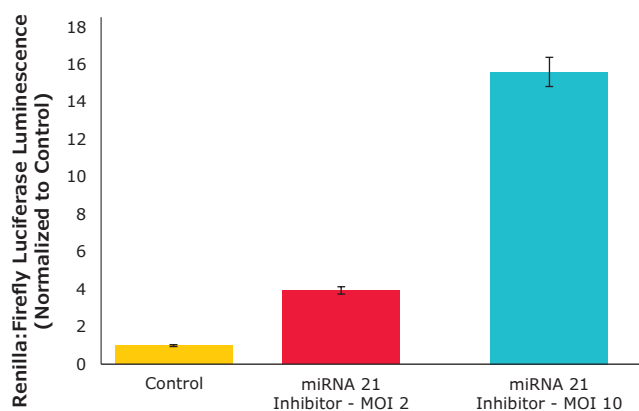

Figure 16. Dual Luciferase Assay for miR-21 in HepG2 Cells. Increased multiplicity of infection (MOI) can be used to increase miRNA inhibition. HepG2 cells were stably transduced with control Lenti miRNA inhibitor or miR-21 inhibitor at varied MOI. Stable pools were transfected with the dual luciferase reporter vector for miR-21, and luciferase ratios were calculated accordingly. Results indicate an increased MOI of Lenti inhibitor can be used to increase inhibition of a specific miRNA, as the Renilla:firefly luminescence increases with higher MOI.

Inhibition of miR-206 Upregulates Notch3 Expression

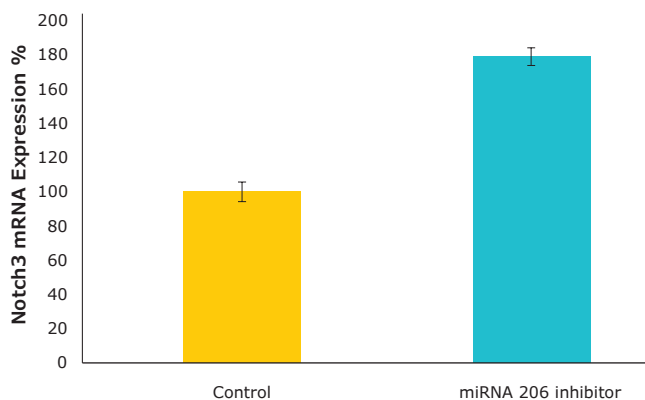

Figure 15. qRT-PCR of Notch3 in HeLa Lenti miRNA Inhibitor Cell Lines. miR-206 has been shown to regulate the expression of Notch3 in HeLa cells. To confirm the miR-206 inhibitor can alter the actions of miR-206 with respect to its endogenous downstream targets, qRT-PCR was performed on total RNA preparations from HeLa cells stably expressing either the miR-206 inhibitor or control inhibitor. Expression of Notch3 increased by 78% relative to control cells, indicating efficient inhibition of miR-206 in this cell line.

Inhibition of miR-21 Upregulates RHOB Expression

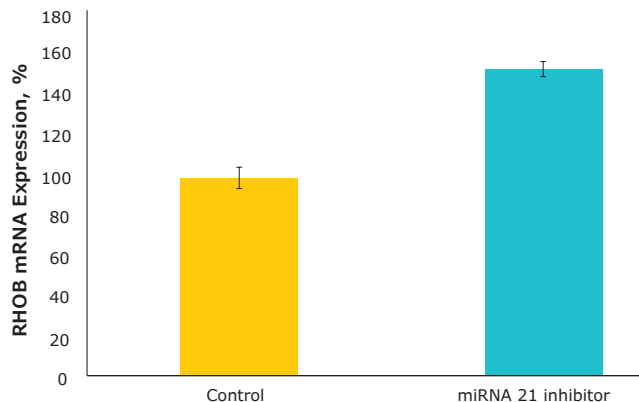

Figure 17. qRT-PCR of RHOB in HepG2 Lenti miRNA Inhibitor Cell Lines. miR-21 has been shown to regulate the expression of RHOB in hepatocytes. To further validate the miR-21 inhibitor, qRT-PCR was performed on total RNA preparations from Hep G2 cells stably expressing either the miR-21 inhibitor or control inhibitor. Expression of RHOB increased by 55% relative to control cells, indicating efficient inhibition of miR-21 in this cell line. Nearly identical results were obtained for this same target and inhibitor combination in HeLa cells (data not shown).

SigmaAldrich.com/LentiInhibitor

Ordering Information

Cat. No.	Product Description
HLTUD0001- HLTUD2235	MISSION® Lenti microRNA Inhibitor, Human
MLTUD0001- MLTUD1405	MISSION® Lenti microRNA Inhibitor, Mouse
HLTUD001C	MISSION® Lenti microRNA Inhibitor, <i>Arabidopsis thaliana</i> Control
HLTUD002C	MISSION® Lenti microRNA Inhibitor, <i>Caenorhabditis elegans</i> Control
CSTTUD	MISSION® Custom Lenti microRNA Inhibitor

To learn more about our lenti miRNA inhibitors, visit [SigmaAldrich.com/LentiInhibitor](https://www.sigmaaldrich.com/LentiInhibitor)

Reference:

1. Haraguchi, T., et al., Vectors expressing efficient RNA decoys achieve the long-term suppression of specific microRNA activity in mammalian cells. *Nucleic Acids Res.*, 37, (2009).

Choosing an RNAi Format

Which should I choose, siRNA or shRNA?

Both methods provide viable knockdown efficiency, to better help you choose please refer to the table below.

Choosing the Appropriate RNAi Effector for your Application

	siRNA	shRNA, Transfected Plasmid	shRNA, Lentivirus-delivered
Cell Lines (<i>actual efficacy highly cell type specific</i>)			
Immortalized/Cancer	+++	+++	+++
(Embryonic) Stem	+	+	+++
Primary	+	+	+++
Screening			
Arrayed (single)	+++	++	+++
Pooled, multiple genes / genome	-	-	+++
Pooled, single gene	+++	+	+
<i>in vivo</i> (routes)			
Intratumoral	+++	+++	+++
<i>ex vivo</i> , implantation	+	+	+++
Cranial	+	+	++
Peritoneum	+	+	++
Muscle	++	++	++

+++ Excellent for this application

++ Works well with this application

+ Could work for this application but consider the other options available

My gene of interest is very stable. Which RNAi format do I choose?

	siRNA	shRNA, Transfected Plasmid	shRNA, Lentivirus-delivered
Silencing Duration	Transient (48 hrs to 1wk)	Transient (48 hrs to 1wk), or Stable, long-term	Stable, long-term
mRNA silenced	6 - 24 hours after transfection	24 - 48 hours after transfection	48 hours after transduction
Protein silenced	48 hours to 5 days post-transfection	48 hours to 5 days post-transfection	72 hours to 6 days post-transduction
Ease of Use	Simple	Moderate	Simple
Standard Order Format	~10 nmoles, desalted	1 µg, TE buffer	200 µL of 1 x 10 ⁶ VP/mL
Custom Options	Yes	Yes	Yes

Discover the entire RNAi portfolio at [SigmaAldrich.com/RNAi](https://www.sigmaaldrich.com/US/en/brands/sigmaaldrich/rnai)



Beyond the Bench

Sigma-Aldrich® Advanced Genomics

How far your research goes depends on how far your partners can help you take it. Research to reality. Discovery to therapeutic impact. We navigate the entire process—so you can too.

Solutions for every step:

- Products: CRISPR, RNAi, Libraries
- Services: Full custom cell engineering
- Custom viral manufacturing

Discover more at
SigmaAldrich.com/AdvancedGenomics

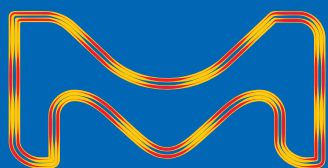

Sigma-Aldrich®
Lab & Production Materials

Sigma-Aldrich®

Lab & Production Materials

Merck KGaA
Frankfurter Strasse 250
64293 Darmstadt, Germany

[SigmaAldrich.com/CRISPR](https://www.sigmaaldrich.com/CRISPR)

To place an order or receive technical assistance

Order/Customer Service: [SigmaAldrich.com/order](https://www.sigmaaldrich.com/order)

Technical Service: [SigmaAldrich.com/techservice](https://www.sigmaaldrich.com/techservice)

Safety-related Information: [SigmaAldrich.com/safetycenter](https://www.sigmaaldrich.com/safetycenter)

© 2021 Merck KGaA, Darmstadt, Germany and/or its affiliates. All Rights Reserved. Merck, the vibrant M, MISSION, LentiPlex, LentiElite and Sigma-Aldrich are trademarks of Merck KGaA, Darmstadt, Germany or its affiliates. All other trademarks are the property of their respective owners. Detailed information on trademarks is available via publicly accessible resources.

MK_BR7266EN Ver. 1.0

33368

03/2021